

Schematic:

REV.	ECN NO.	DESCRIPTION	DATE	APPD
A6	REL		2023-03-19	

PC BOARD CONNECTIONS

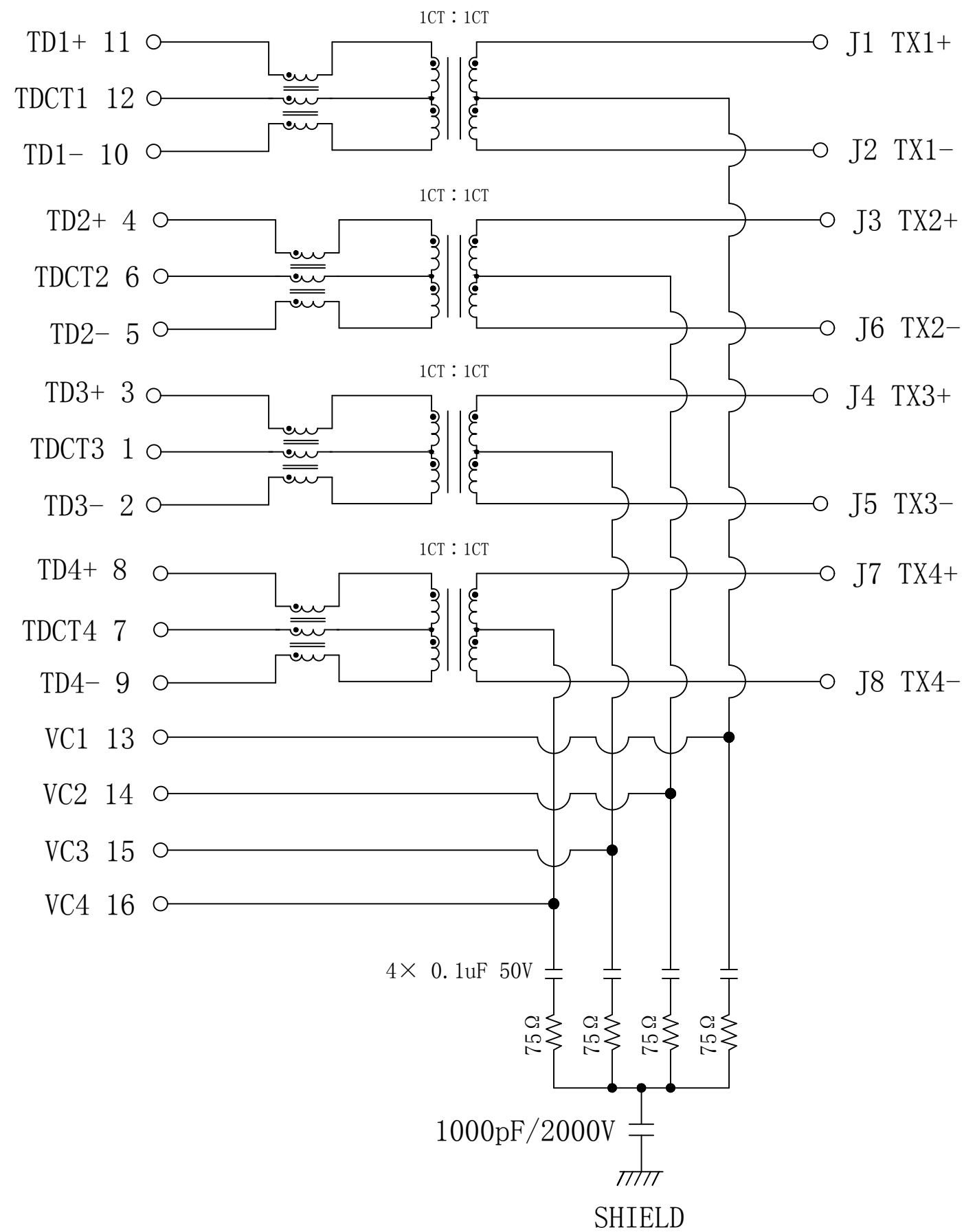

RJ45 CONNECTOR

ELECTRICAL SPECIFICATIONS @25°C

- Turn Ratio : 1CT:1CT $\pm 5\%$
- OCL: 160uH Min @100KHz , 0.1V
- Insertion Loss (dB Max):

1-125MHz: -1.0	125-200MHz: -2.0
200-250MHz: -2.5	
- Return Loss (dB Min):

1-30MHz: -18	30-100MHz: -14
100-200MHz: -11	200-250MHz: -9
- Cross Talk:

1-250MHz: -25dB Min.

- Common Mode Rejection (dB Min):

1-100MHz: -30	100-250MHz: -20
---------------	-----------------
- Common Mode to Differential Mode Rejection (dB Min):

1-100MHz: -30	100-250MHz: -25.
---------------	------------------
- Balance DC Line current:

720mA MAX, @57VDC Continuous;

- Isolation PHY SIDE To Line SIDE : 1500Vrms
- Operating Temperature Range: 0°C ~ 70°C.

X:X ± 0.30	APPD: TOM	LINK-PP INT'L TECHNOLOGY CO., LIMITED		
X:XX ± 0.25	CHKD: JAMES			
X:XXX ± 0.05	DR: LEO	TITLE: RJ45 Connector with 5G Base-T Integrated Magnetics For PoE+ Application		
ANGLES $\pm 1^\circ$	UNIT: mm	PART NO. : LPJQ95282-8CNL		
	SCALE: 2/1	SHEET: 1/2	REV: A6	DWG NO. : LP23031965



Mechanical :

REV.	ECN NO.	DESCRIPTION	DATE	APPD
A6	REL		2023-03-19	

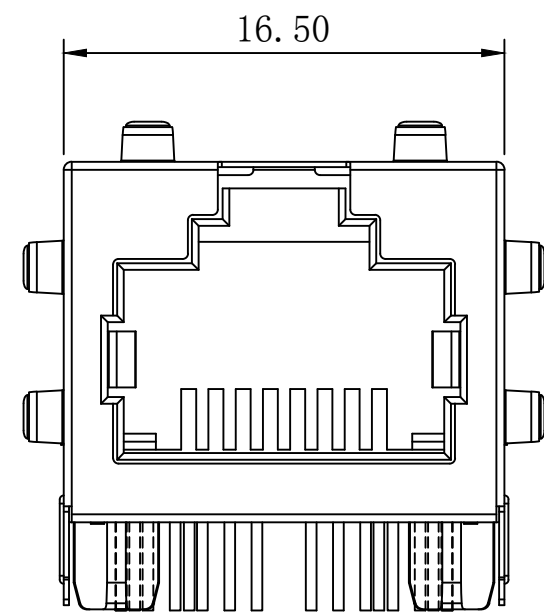

Front Side View

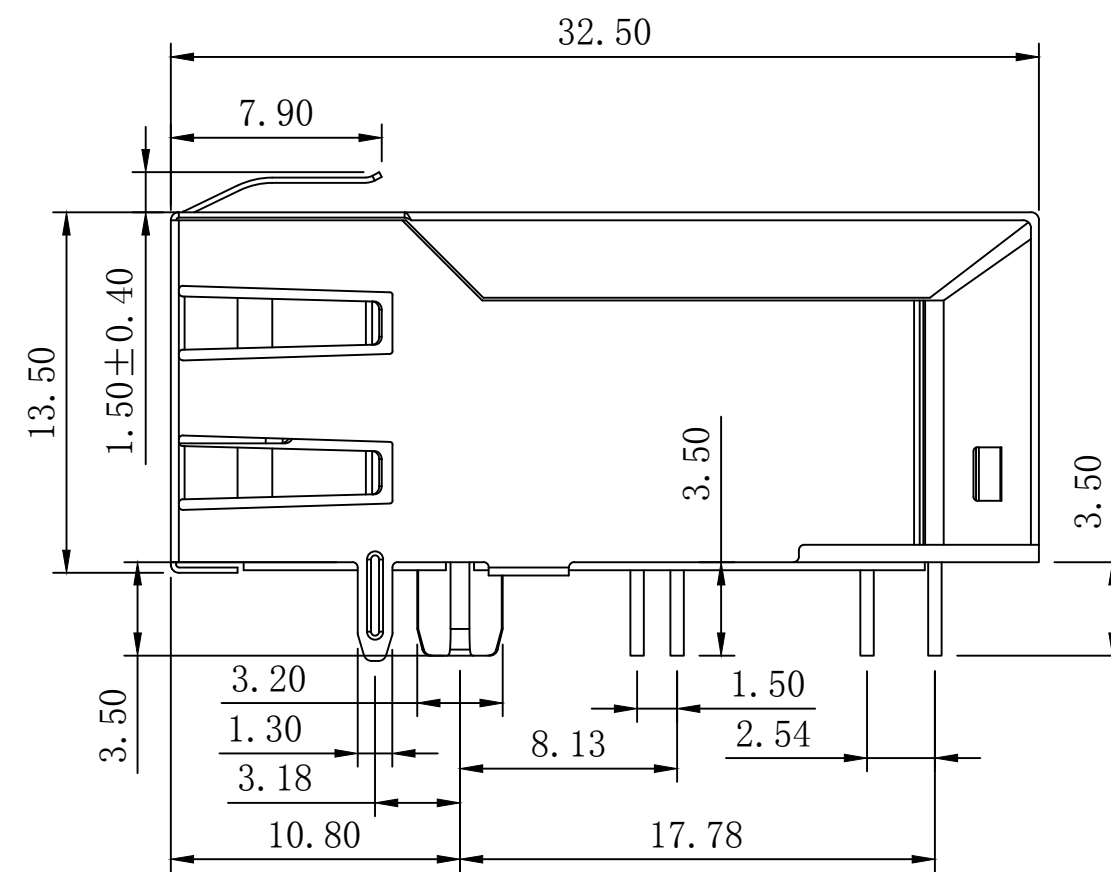

Left Side View

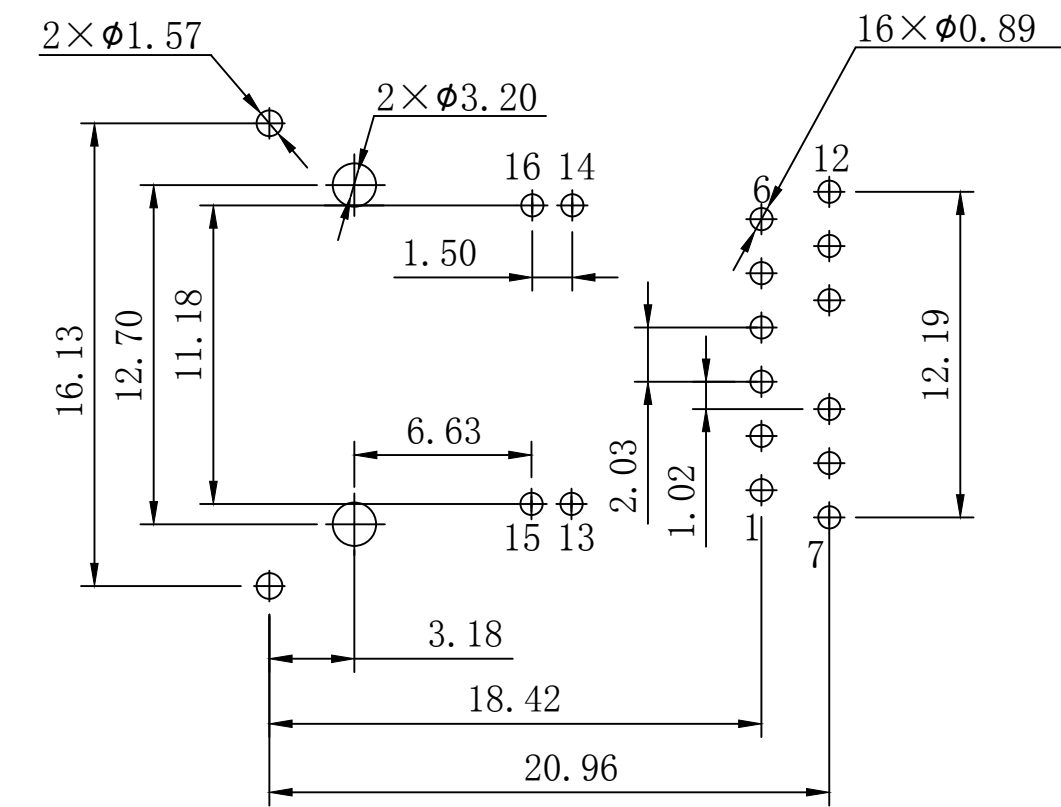

Suggested PCB Layout (Top View)

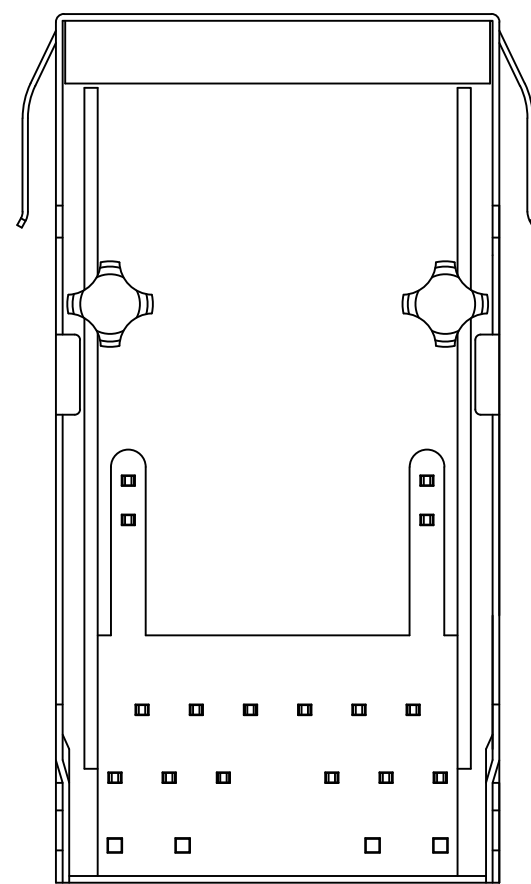

Bottom Side View

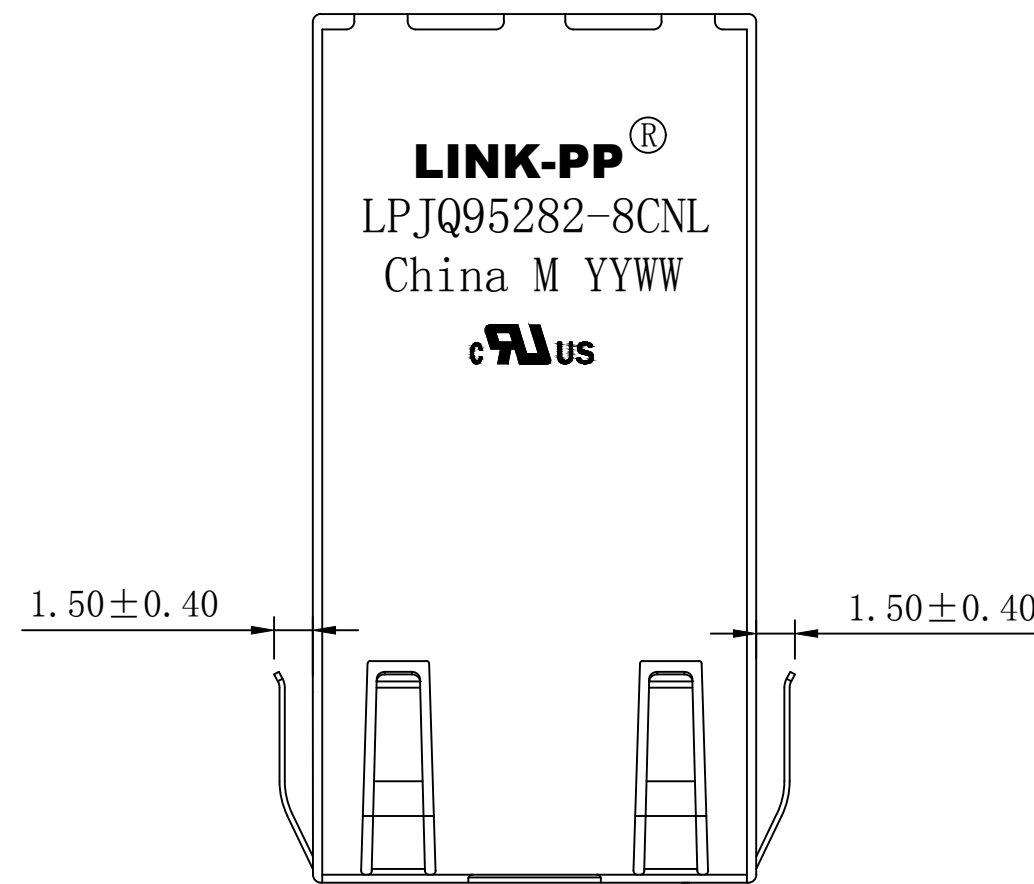

Top Side View

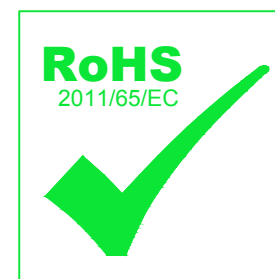

NOTES:

1. Designed to support application, such as SOHO (ADSL modems), LAN-on-Motherboard (LOM), hub and Switches.
2. Meets IEEE 802.3at specification
3. Connector Materials:
 Housing Material: Thermoplastic PBT+30%G.F UL94V-0
 Contact Material: Phosphor Bronze C5210R-EH Thickness=0.35mm
 Pins: Brass C2680R-H Thickness=0.35mm
 Shield: SUS 304 1/2EH Thickness=0.2mm
 Contact plating: Gold 6 micro-inches min. In contact area.
4. Wave solder tip temperature: 250°C, 5 Sec.
5. UL Certification: File Number E484635.

X:X ±0.30	APPD: TOM	LINK-PP INT'L TECHNOLOGY CO., LIMITED
X:XX ±0.25	CHKD: JAMES	
X:XXX ±0.05	DR: LEO	TITLE: RJ45 Connector with 5G Base-T Integrated Magnetics For PoE+ Application
ANGLES ±1°	UNIT: mm	PART NO.: LPJQ95282-8CNL
	SCALE: 2/1	SHEET: 2/2
	REV: A6	DWG NO.: LP23031965