

# Schematic:

REV.	ECN NO.	DESCRIPTION	DATE	APPD
A6	REL		2023-03-18	

PC BOARD CONNECTIONS

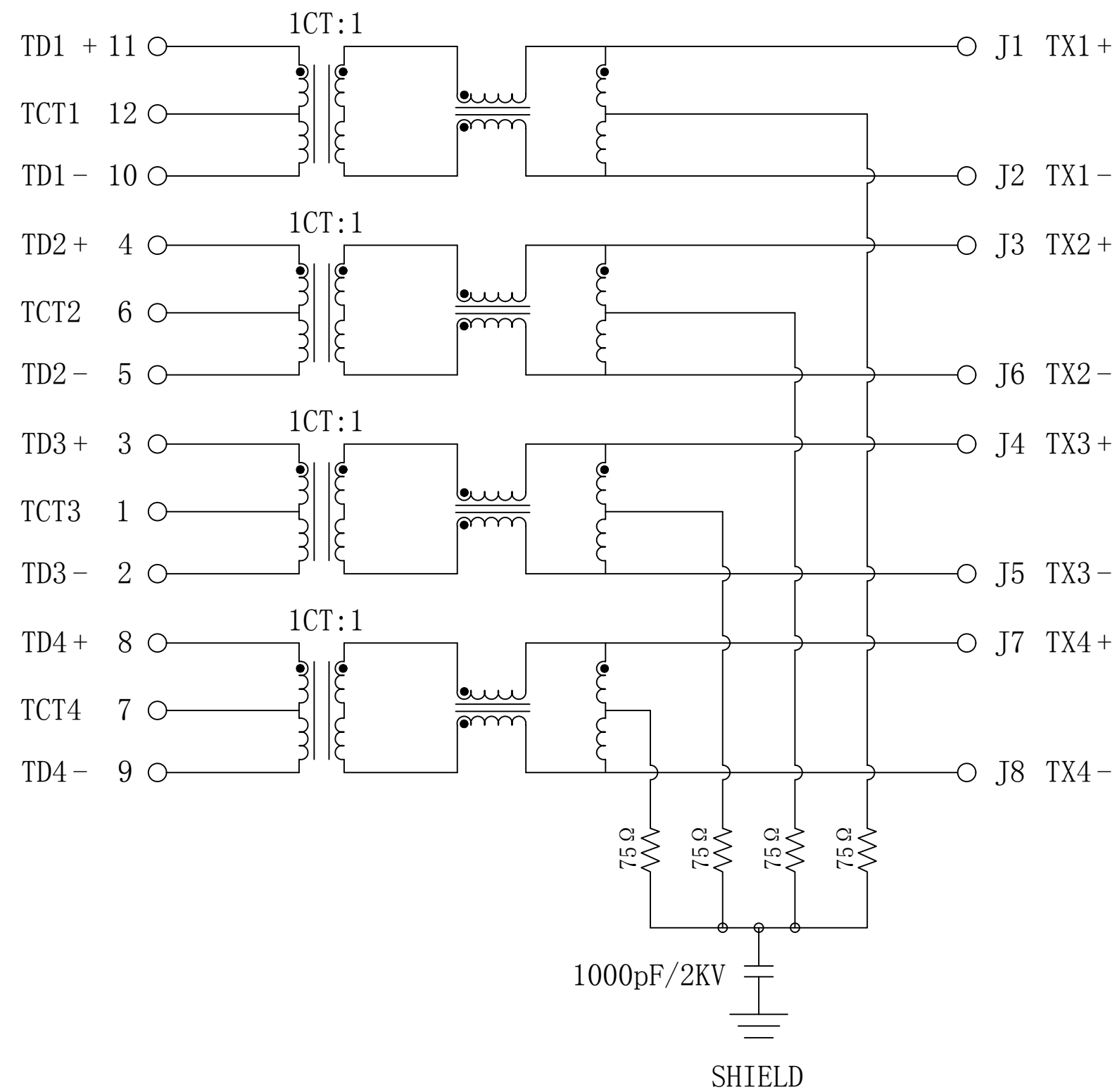

RJ45 CONNECTOR

### Electrical Specifications @25°C

- Turns Ratio:  
 (P11-P10) : (J1-J2) : 1 : 1 ±2%  
 (P4-P5) : (J3-J6) : 1 : 1 ±2%  
 (P3-P2) : (J4-J5) : 1 : 1 ±2%  
 (P8-P9) : (J7-J8) : 1 : 1 ±2%
- Inductance:  
 (P11-P10); (P4-P5); (P3-P2); (P8-P9):  
 350uH MIN. @ 100KHz, 0.1V, 8mA DC BIAS
- Insertion Loss:  
 1~100MHz:-1.0dB MAX
- Return Loss (dB MIN):  
 1~10MHz:-20      30MHz:-16  
 60~80MHz:-12      80~100MHz:-10
- Crosstalk (dB MIN):  
 1~10MHz:-40      32~65MHz:-35  
 65~100MHz:-30
- Common To Common Mode (dB MIN):  
 1~100MHz:-30
- Isolation PHY SIDE To Line SIDE : 1500Vrms
- Operating Temperature: -40°C ~ +85°C.

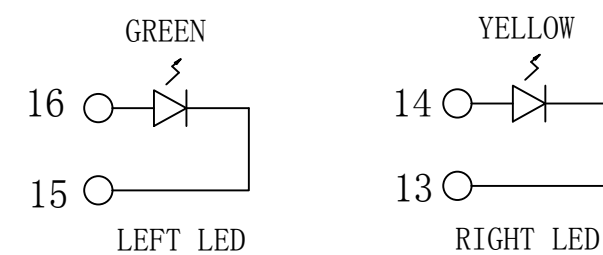

Emitting Color	λp(nm)	VF@IF=20mA	IR @VR=5V
YELLOW	585	1.8~2.6V	10 μA max
GREEN	565	1.8~2.6V	10 μA max

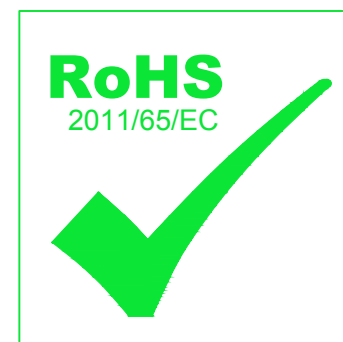

X:X ±0.30	APPD: TOM	LINK-PP INT'L TECHNOLOGY CO., LIMITED		
X:XX ±0.25	CHKD: JAMES			
X:XXX ±0.05	DR: LEO	TITLE: RJ45 Connector with 1000 Base-T Integrated Magnetics		
ANGLES ±1°	UNIT: mm	PART NO.: LPJK4071AHNL		
	SCALE: 2/1	SHEET: 1/2	REV: A6	DWG NO.: LP23031821

# Mechanical :

REV.	ECN NO.	DESCRIPTION	DATE	APPD
A6	REL		2023-03-18	

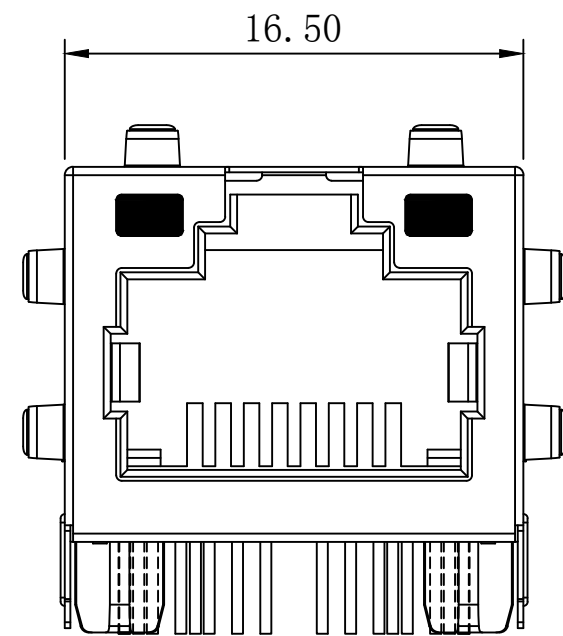

Front Side View

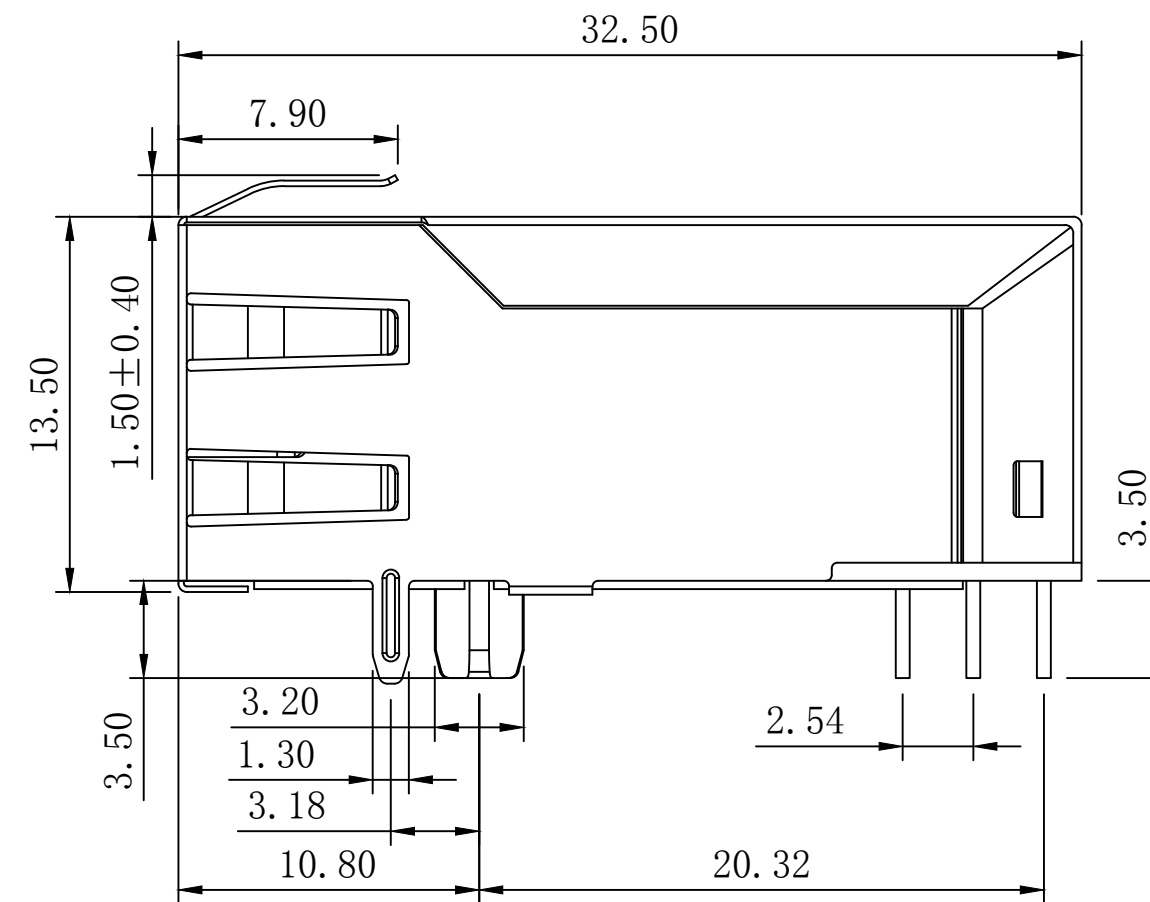

Left Side View

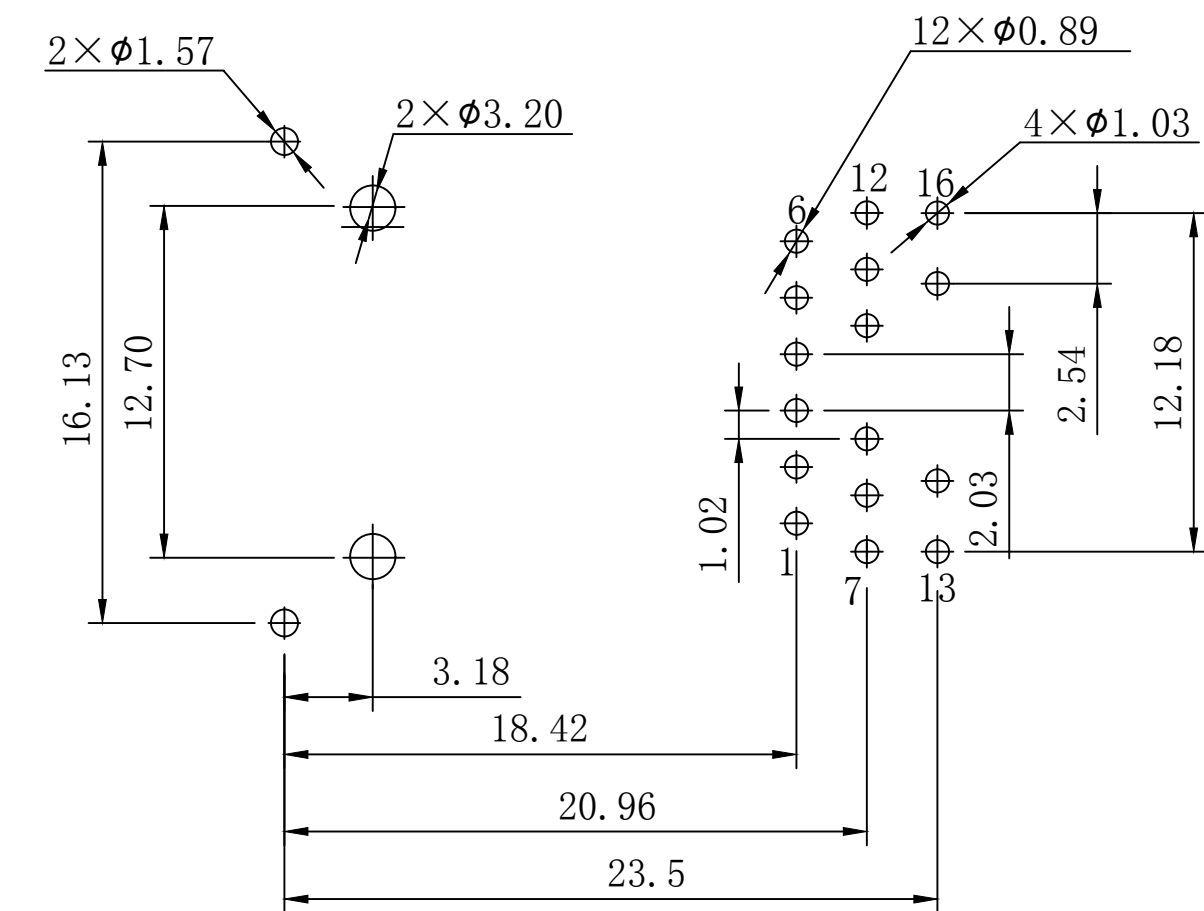

Suggested PCB Layout (Top View)

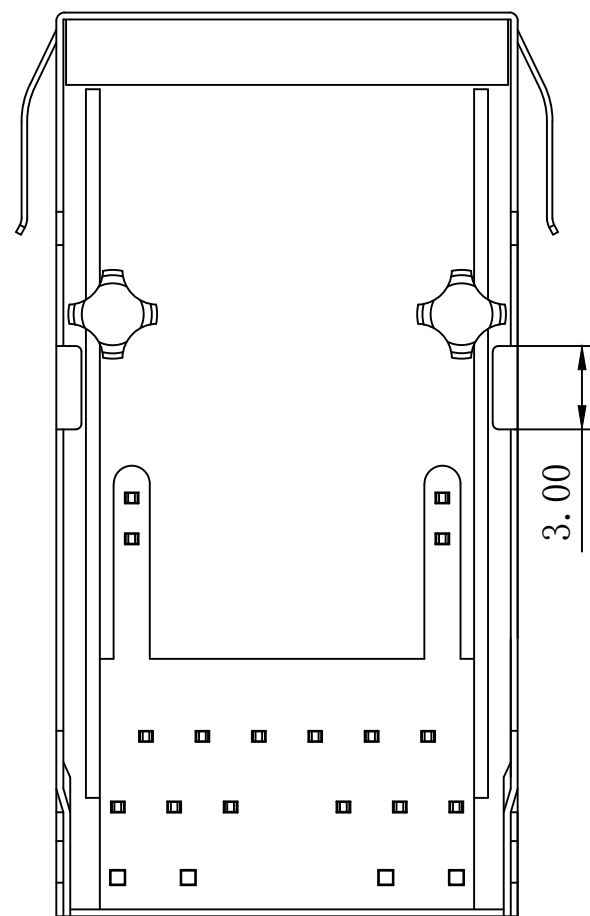

Bottom Side View

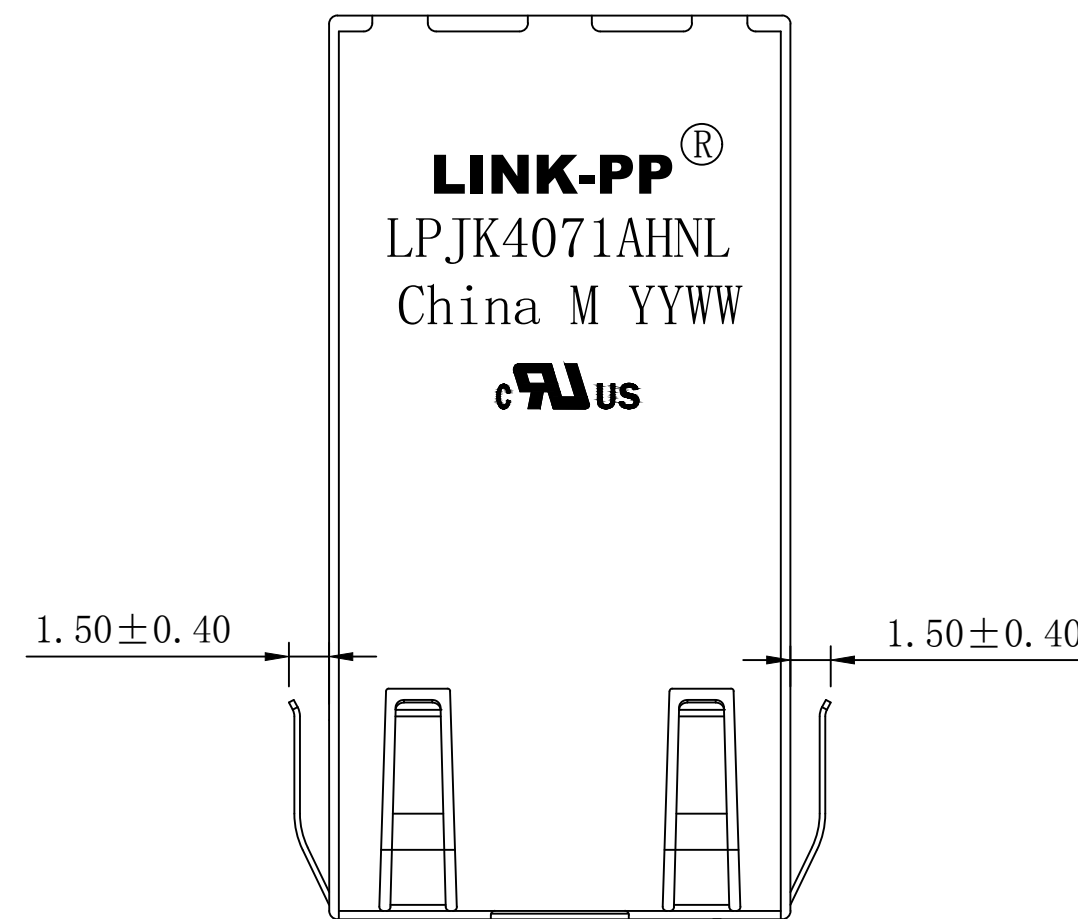

Top Side View

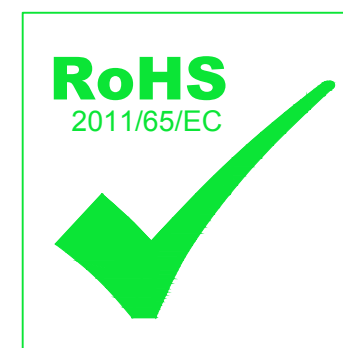

## NOTES:

1. Designed to support application, such as SOHO (ADSL modems), LAN-on-Motherboard (LOM), hub and Switches.
2. Meets IEEE 802.3 specification
3. Connector Materials:  
 Housing Material: Thermoplastic PBT+30%G.F UL94V-0  
 Contact Material: Phosphor Bronze C5210R-EH Thickness=0.35mm  
 Pins: Brass C2680R-H Thickness=0.35mm  
 Shield: SUS 304 1/2EH Thickness=0.2mm  
 Contact plating: Gold 6 micro-inches min. In contact area.
4. Wave solder tip temperature: 250°C, 5 Sec.
5. UL Certification: File Number E484635.

X:X ±0.30	APPD: TOM	LINK-PP INT'L TECHNOLOGY CO., LIMITED
X:XX ±0.25	CHKD: JAMES	
X:XXX ±0.05	DR: LEO	TITLE: RJ45 Connector with 1000 Base-T Integrated Magnetics
ANGLES ±1°	UNIT: mm	PART NO.: LPJK4071AHNL
	SCALE: 2/1	SHEET: 2/2
	REV: A6	DWG NO.: LP23031821