

# Schematic:

REV.	ECN NO.	DESCRIPTION	DATE	APPD
A6	REL		2023-03-16	

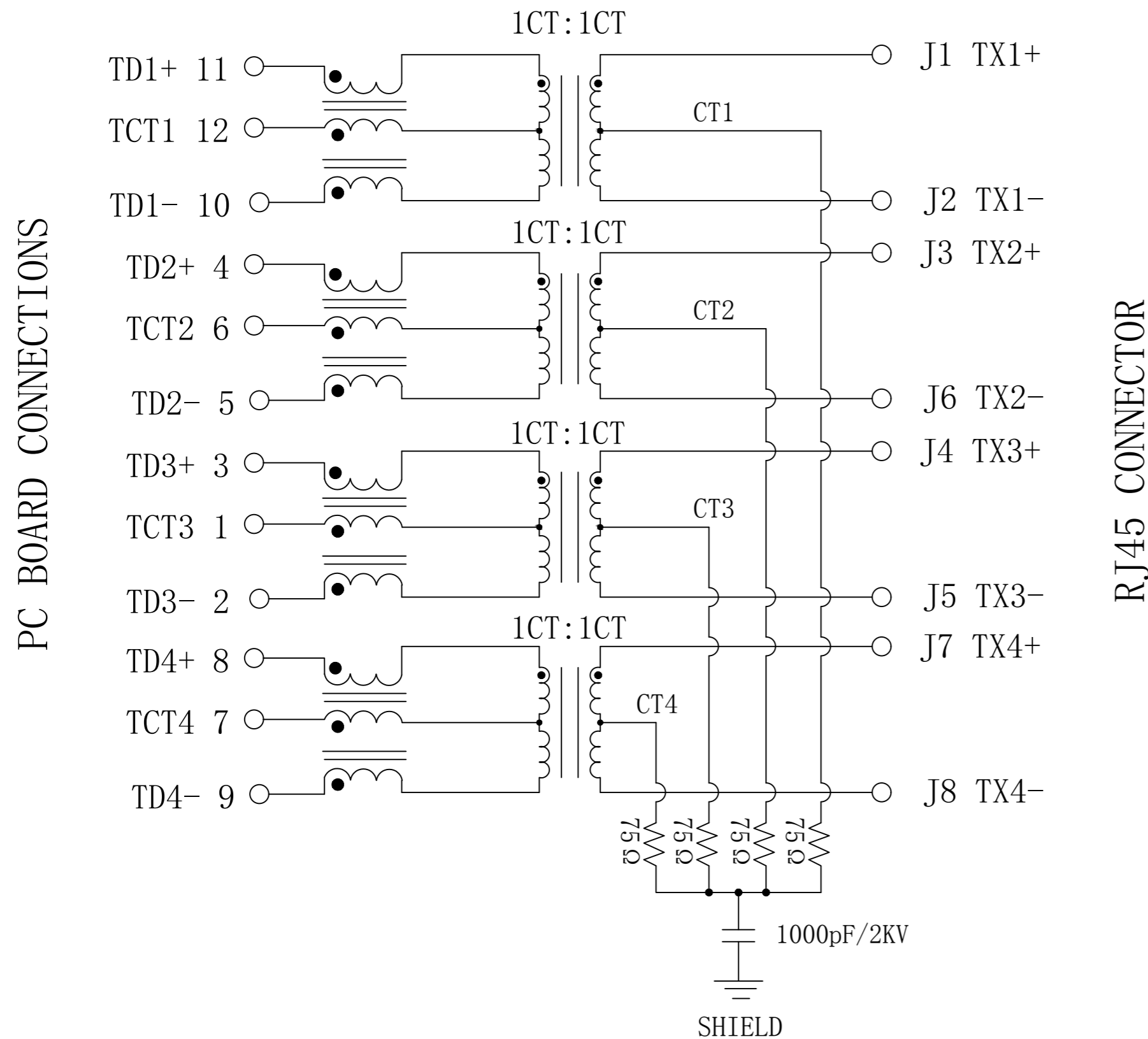

## Electrical Specifications @25°C

- Turns Ratio ( $\pm 2\%$ ):  
Pri : Sec = 1CT : 1CT
- OCL (@100KHz, 100mV, 8mA DC Bias):  
350uH Min
- Insertion Loss:  
1~100MHz: -1.0dB Max
- Return Loss (dB Min):  
1~10MHz: -20 ; 30MHz: -16  
60~80MHz: -12 ; 80~100MHz: -10
- Crosstalk (dB Min):  
1~10MHz: -40 ; 32~65MHz: -35  
65~100MHz: -30
- Common Mode Rejection (dB Min):  
1~100MHz: -30
- Isolation PHY SIDE To Line SIDE : 1500Vrms
- Operating Temperature: 0°C ~ 70°C.

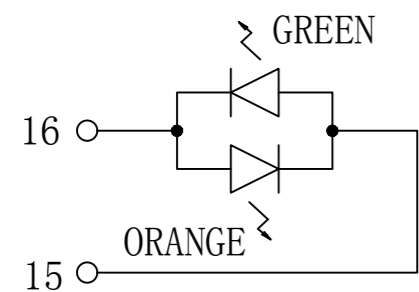

LEFT LED

LED POLARITY		COLOR
PIN 16	PIN 15	COLOR
+	-	ORANGE
-	+	GREEN

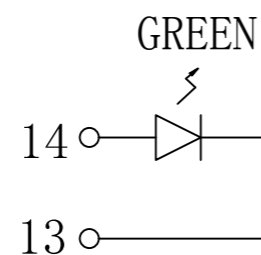

RIGHT LED

LED POLARITY		COLOR
PIN 14	PIN 13	COLOR
+	-	GREEN



Emitting Color	$\lambda_p$ (nm)	V <sub>F</sub> @I <sub>F</sub> =20mA	I <sub>R</sub> @V <sub>R</sub> =5V
GREEN	565	1.8~2.6V	10 $\mu$ A max
ORANGE	610	1.8~2.6V	10 $\mu$ A max

X:X $\pm 0.30$	APPD: TOM	LINK-PP INT'L TECHNOLOGY CO., LIMITED	
X:XX $\pm 0.25$	CHKD: JAMES	TITLE: RJ45 Connector with 1000 Base-T Integrated Magnetics	
X:XXX $\pm 0.05$	DR: LEO	PART NO.: LPJK0036AYNL	
ANGLES $\pm 1^\circ$	UNIT: mm	DWG NO.: LP23031663	
	SCALE: 2/1	SHEET: 1/2	REV: A6

# Mechanical :

REV.	ECN NO.	DESCRIPTION	DATE	APPD
A6	REL		2023-03-16	

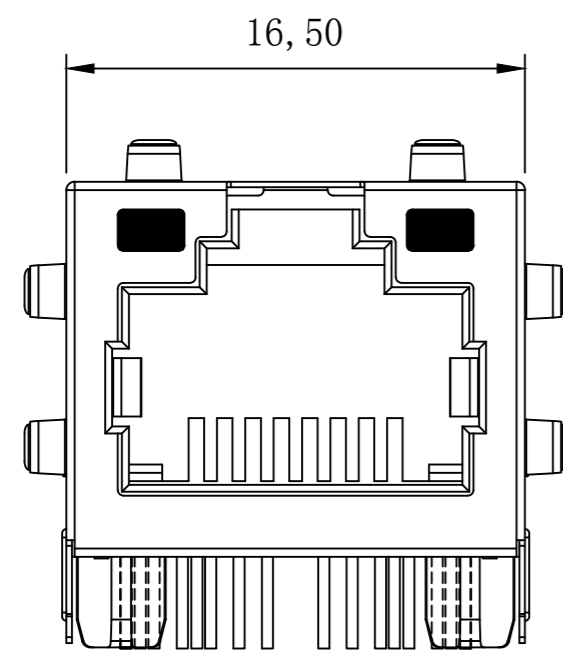

Front Side View

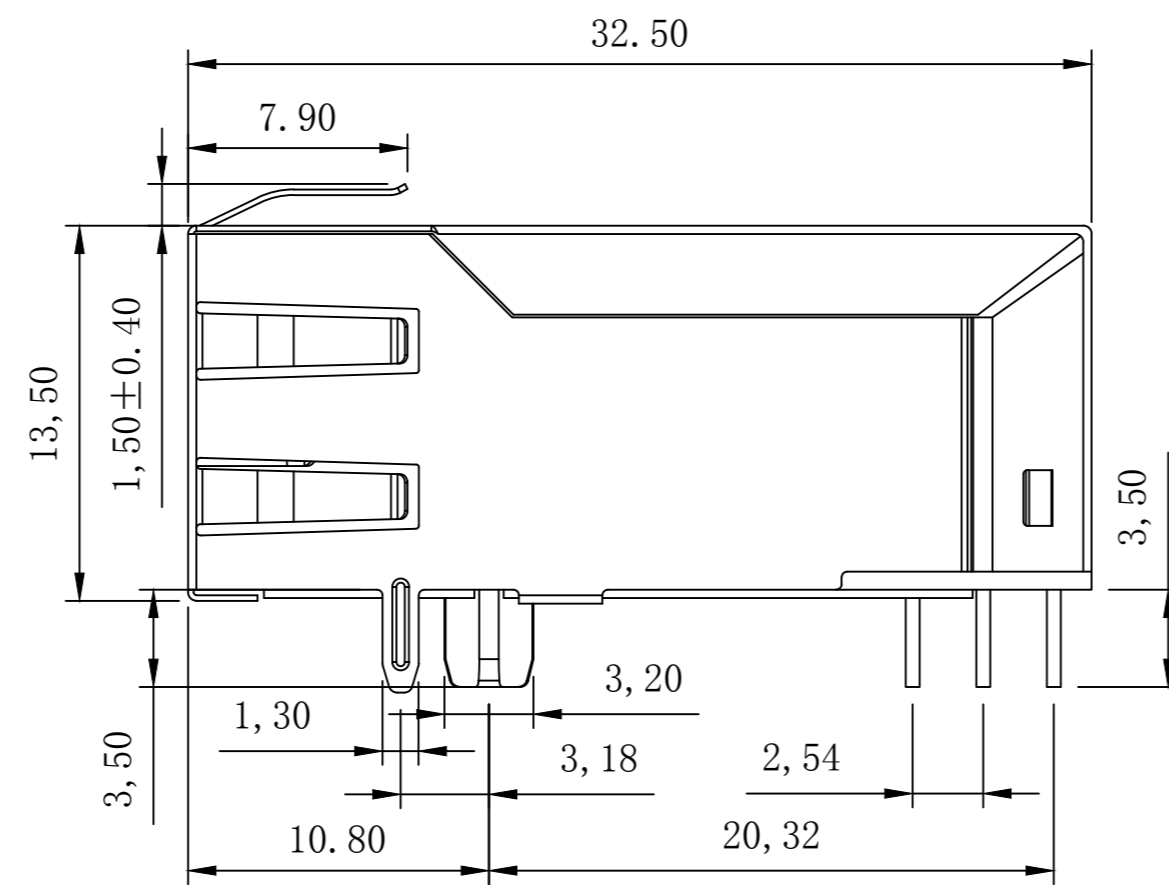

Left Side View

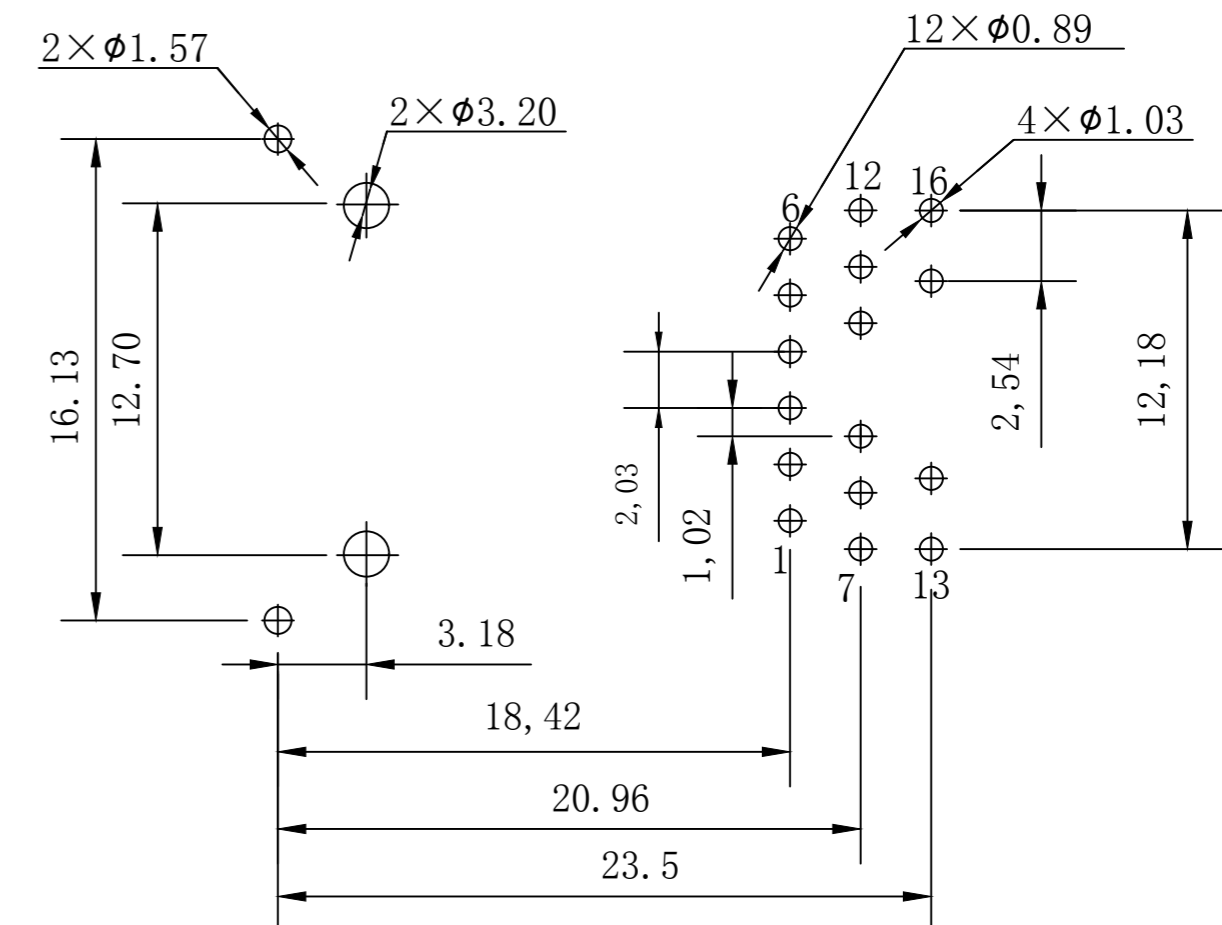

Suggested PCB Layout (Top View)

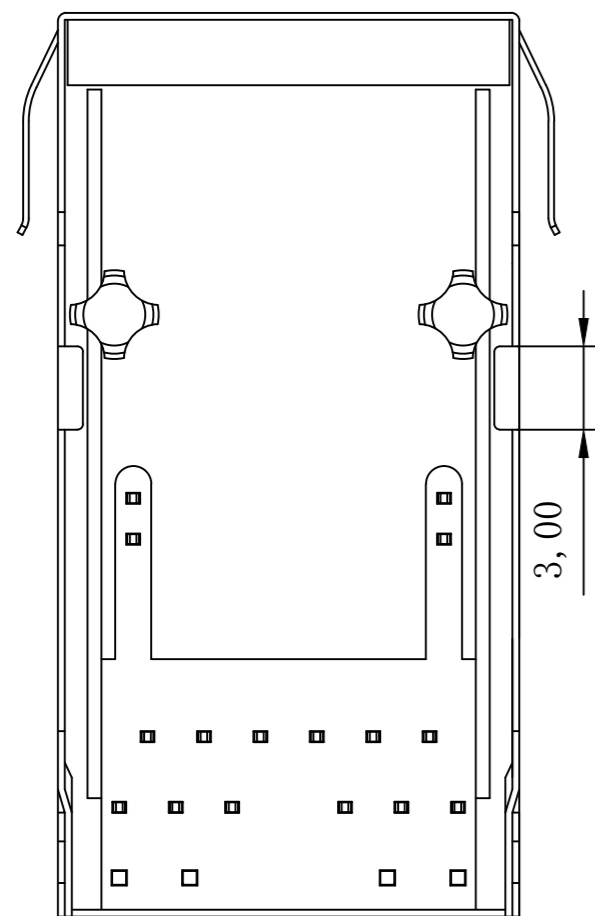

Bottom Side View

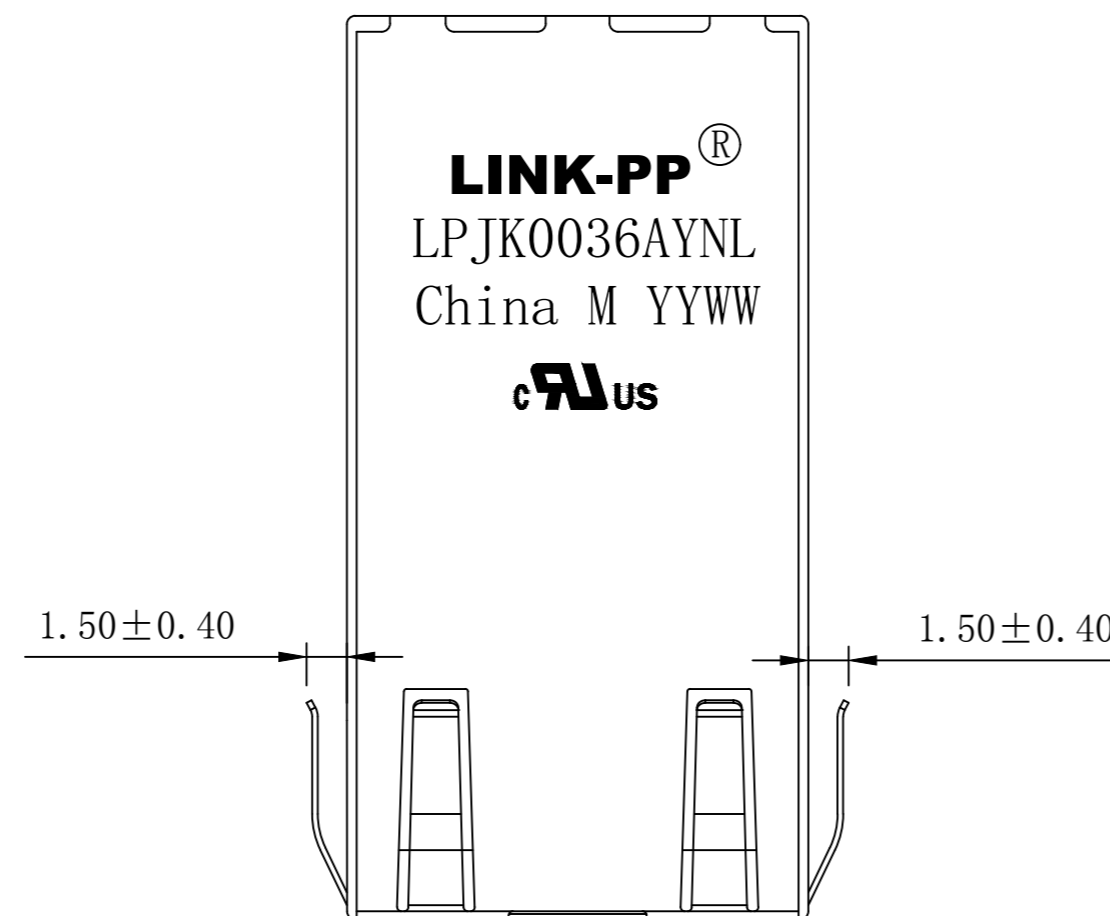

Top Side View

## NOTES:

1. Designed to support application, such as SOHO (ADSL modems), LAN-on-Motherboard (LOM), hub and Switches.
2. Meets IEEE 802.3 specification
3. Connector Materials:  
 Housing Material: Thermoplastic PBT+30%G. F UL94V-0  
 Contact Material: Phosphor Bronze C5210R-EH Thickness=0.35mm  
 Pins: Brass C2680R-H Thickness=0.35mm  
 Shield: SUS 304 1/2EH Thickness=0.2mm  
 Contact plating: Gold 6 micro-inches min. In contact area.
4. Wave solder tip temperature: 250°C, 5 Sec.
5. UL Certification: File Number E484635.

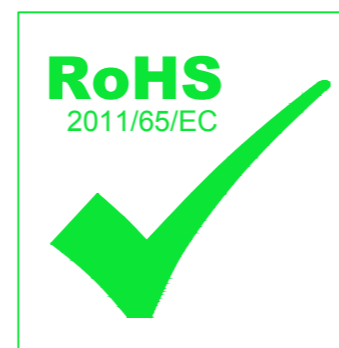

X:X ±0.30	APPD: TOM	LINK-PP INT'L TECHNOLOGY CO., LIMITED
X:XX ±0.25	CHKD: JAMES	
X:XXX ±0.05	DR: LEO	TITLE: RJ45 Connector with 1000 Base-T Integrated Magnetics
ANGLES ±1°	UNIT: mm	PART NO.: LPJK0036AYNL
	SCALE: 2/1	SHEET: 2/2
	REV: A6	DWG NO.: LP23031663