

Schematic:

| REV. | ECN NO. | DESCRIPTION | DATE | APPD |
|------|---------|-------------|------------|------|
| A | REL | | 2014-07-21 | |

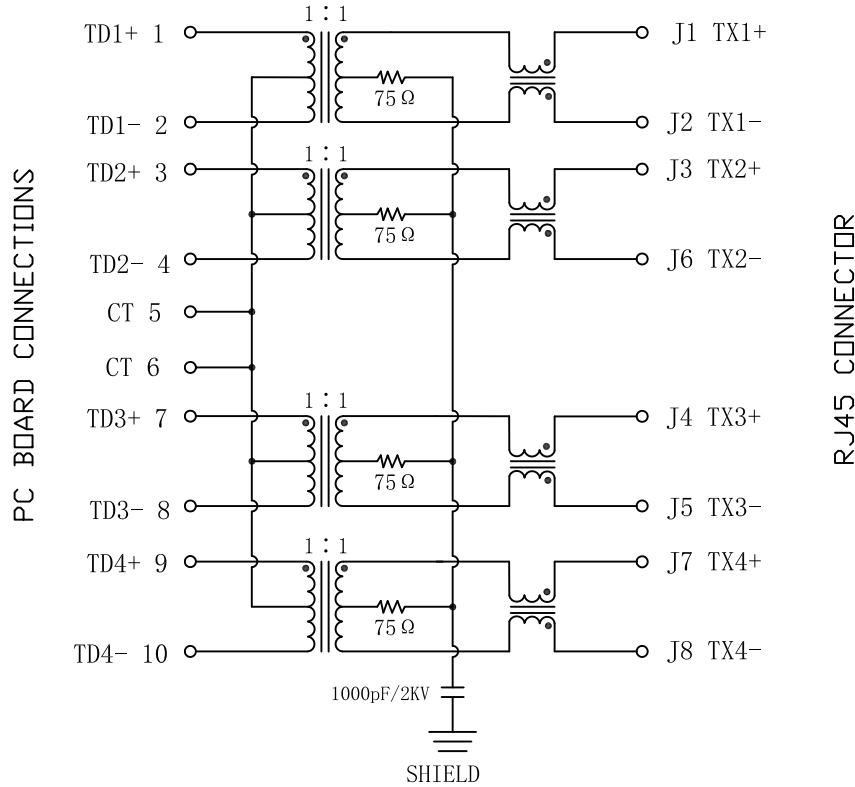

- Electrical Specifications @ 25°C
- Turns Ratio(±2%):
Pri:Sec = 1CT:1CT
 - Inductance(@100KHz, 100mV, 8mA DC BIAS):
J1-J2;J3-J6;J4-J5;J7-J8: 350uH min
 - Insertion Loss:
1~100MHz:-1.0dB Max
 - Return Loss(dB Min. load 100Ω):
1~30MHz:-18 30~60MHz:-16
60~80MHz:-12 80~100MHz:-10
 - Crosstalk(dB Min):
1~30MHz:-40 30~60MHz:-35
60~100MHz:-30
 - Common Mode Rejection(dB Min):
1~50MHz:-40 50~150MHz:-30
 - Isolation Voltage: 1500Vrms
 - Operating Temperature Range: -40°C~+85°C.

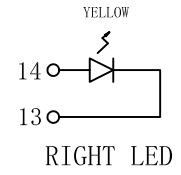
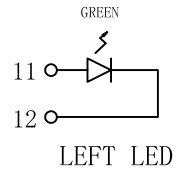
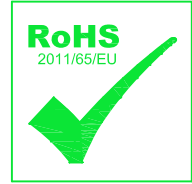

| Emitting Color | λ_p (nm) | VF@IF=20mA | IR @VR=5V |
|----------------|------------------|------------|----------------|
| GREEN | 565 | 1.8~2.6V | 10 μ A max |
| YELLOW | 585 | 1.8~2.6V | 10 μ A max |

| | | | | |
|--------|------------|------------|---|---------------------|
| X:X | ±0.30 | APPD: | LINK-PP INT'L TECHNOLOGY CO., LIMITED | |
| X:XX | ±0.25 | CHKD: | TITLE: RJ45 Connector with 1000 Base-T Integrated Magnetics | |
| X:XXX | ±0.05 | DR: TOM | | |
| ANGLES | ±1° | UNIT: mm | PART NO.: LPJG4801BBNL | |
| | SCALE: 2/1 | SHEET: 2/2 | REV: A | DWG NO.: LP14112711 |

Mechanical:

| REV. | ECN NO. | DESCRIPTION | DATE | APPD |
|------|---------|-------------|------------|------|
| A | REL | | 2014-07-21 | |

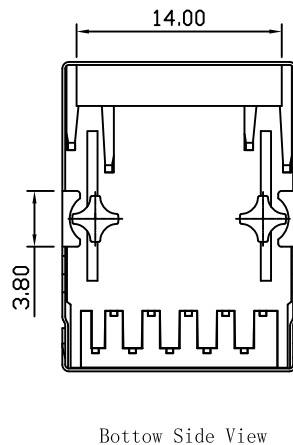
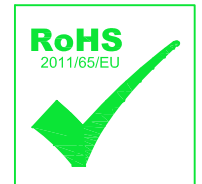
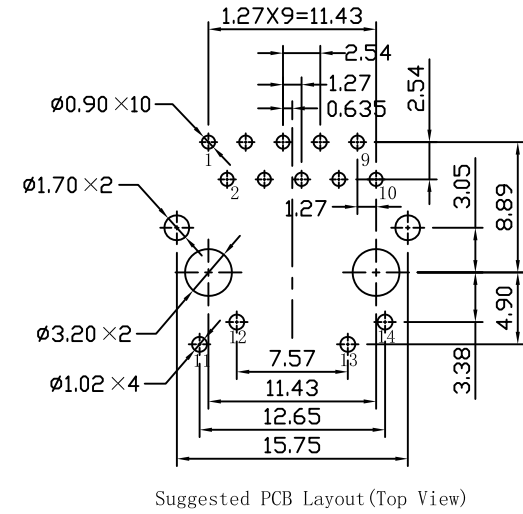
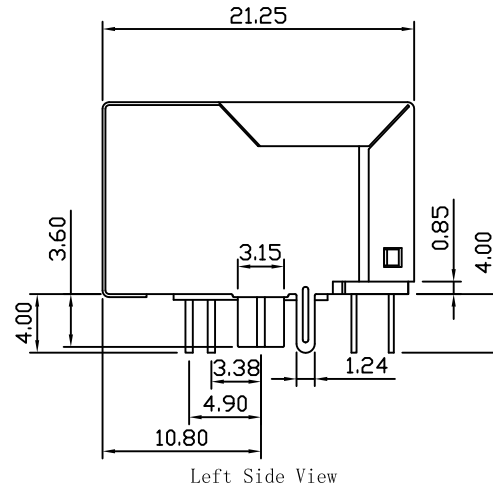
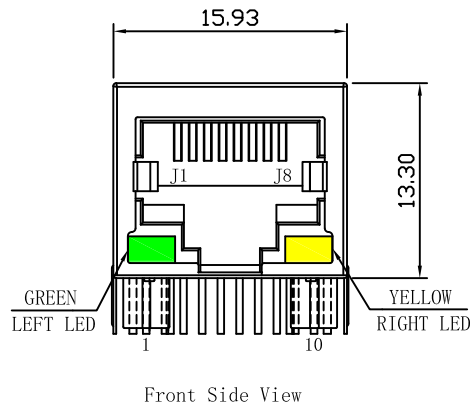

NOTES:

1. Designed to support application, such as SOHO (ADSL modems), LAN-on-Motherboard (LOM), hub and Switches.
2. Meets IEEE 802.3 specification
3. Connector Materials:
 Housing: Thermoplastic PBT+30%G.F UL94V-0
 Contact: Phosphor Bronze C5210R-EH Thickness=0.35mm
 Pins: Brass C2680R-H Thickness=0.35mm
 Shield: SUS 201-1/2H Thickness=0.2mm
 Contact plating: Gold 6 micro-inches min. In contact area.
4. Wave solder tip temperature: 265°C Max, 5 Sec Max.
5. UL Certification: File Number E484635.

| | | |
|-------------|------------|---|
| X:X ±0.30 | APPD: | LINK-PP INT'L TECHNOLOGY CO., LIMITED |
| X:XX ±0.25 | CHKD: | |
| X:XXX ±0.05 | DR: TOM | TITLE: RJ45 Connector with 1000 Base-T Integrated Magnetics |
| ANGLES ±1° | UNIT: mm | PART NO.: LPJG4801BBNL |
| | SCALE: 2/1 | SHEET: 2/2 |
| | REV: A | DWG NO.: LP14112711 |