

Schematic:

| REV. | ECN NO. | DESCRIPTION | DATE | APPD |
|------|---------|-------------|------------|------|
| A | REL | | 2015-06-11 | |

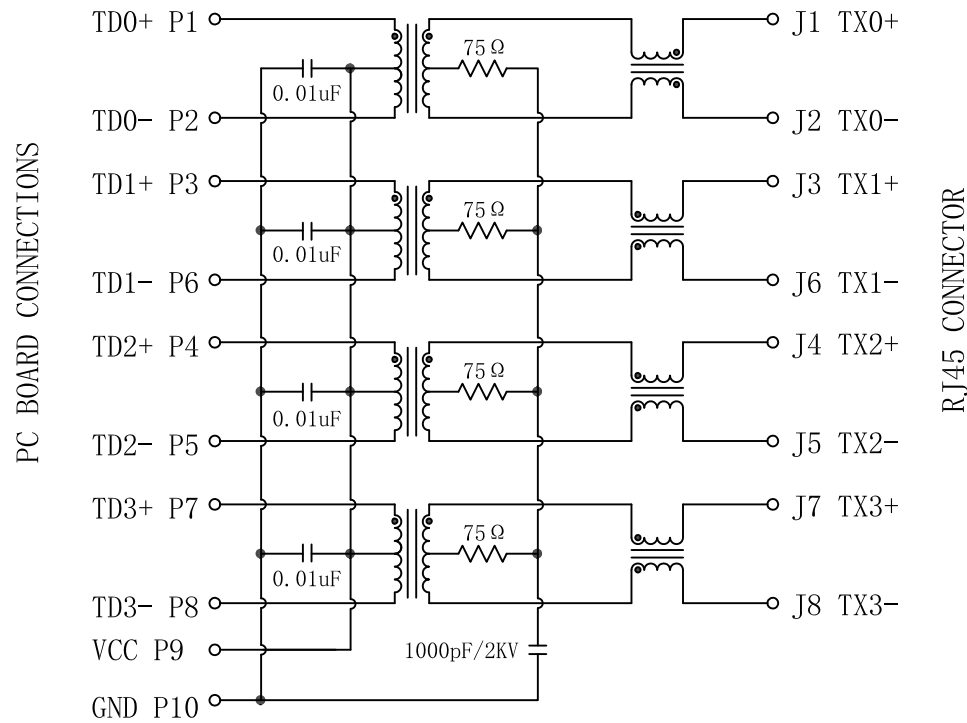

ELECTRICAL SPECIFICATIONS@25°C

- Turn Ratio($\pm 2\%$):
Pri:Sec = 1CT:1CT
- Inductance OCL: 350uH MIN
@100KHz/0.1V, 8mA DC Bias
- Insertion Loss:
-1.0dB MAX @ 1.0-65MHz
- Return Loss:
-20dB MIN @ 1-10MHz
-16dB MIN @ 10-30MHz
-12dB MIN @ 30-60MHz
-10dB MIN @ 60-100MHz
- Cross talk:
-40dB MIN @ 1-30MHz
-35dB MIN @ 30-60MHz
-30dB MIN @ 60-100MHz
- Common Mode Rejection:
-35dB MIN @ 1-125MHz
- Hipot: 1500Vrms MIN
- Operating Temperature: 0°C TO 70°C.

| Emitting Color | λ p(nm) | VF@IF=20mA | IR @VR=5V |
|----------------|-----------------|------------|----------------|
| GREEN | 565 | 1.8~2.6V | 10 μ A max |
| YELLOW | 585 | 1.8~2.6V | 10 μ A max |

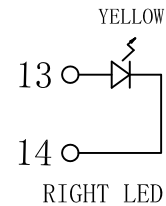
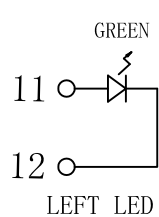

| | | | |
|----------------------|------------|-------------------------|---|
| X:X | ± 0.30 | APPD: | LINK-PP INT'L TECHNOLOGY CO., LIMITED |
| X:XX | ± 0.25 | CHKD: | |
| X:XXX | ± 0.05 | DR: TOM | |
| ANGLES $\pm 1^\circ$ | | | TITLE: 1*2 RJ45 Connector with 1000 BASE-T Integrated Magnetics |
| UNIT: mm | | PART NO.: LPJG26813AENL | |
| | SCALE: 2/1 | SHEET: 1/2 | REV: A |
| DWG NO.: LP15042753 | | | |

Mechanical:

| REV. | ECN NO. | DESCRIPTION | DATE | APPD |
|------|---------|-------------|------------|------|
| A | REL | | 2015-06-11 | |

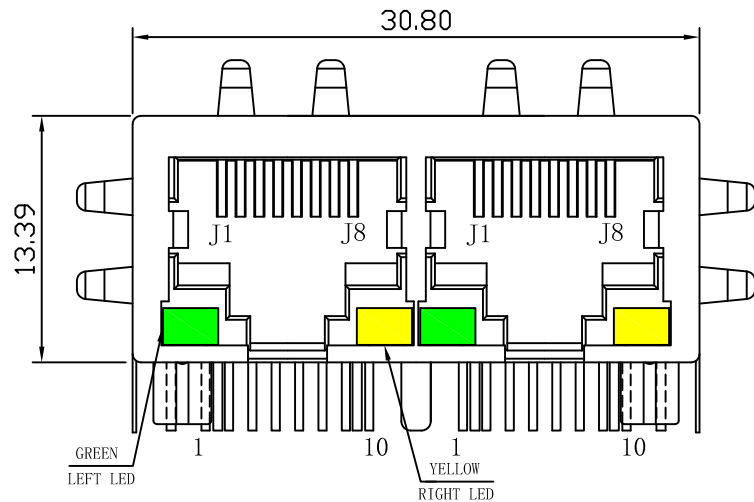

Front Side View

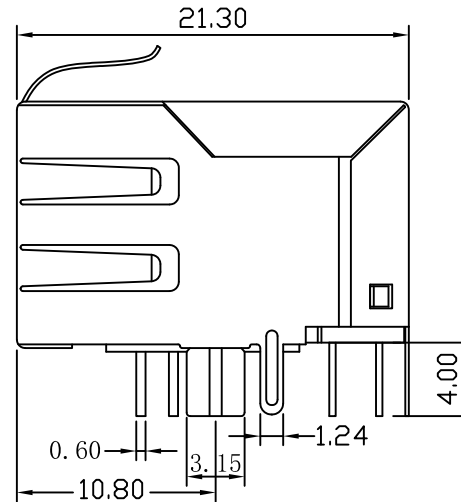

Left Side View

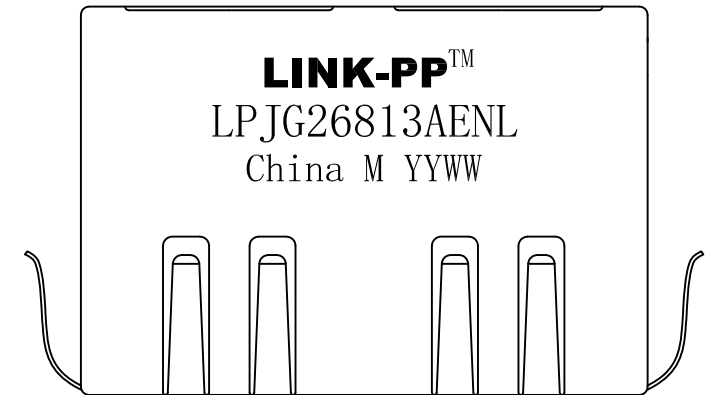

Top Side View

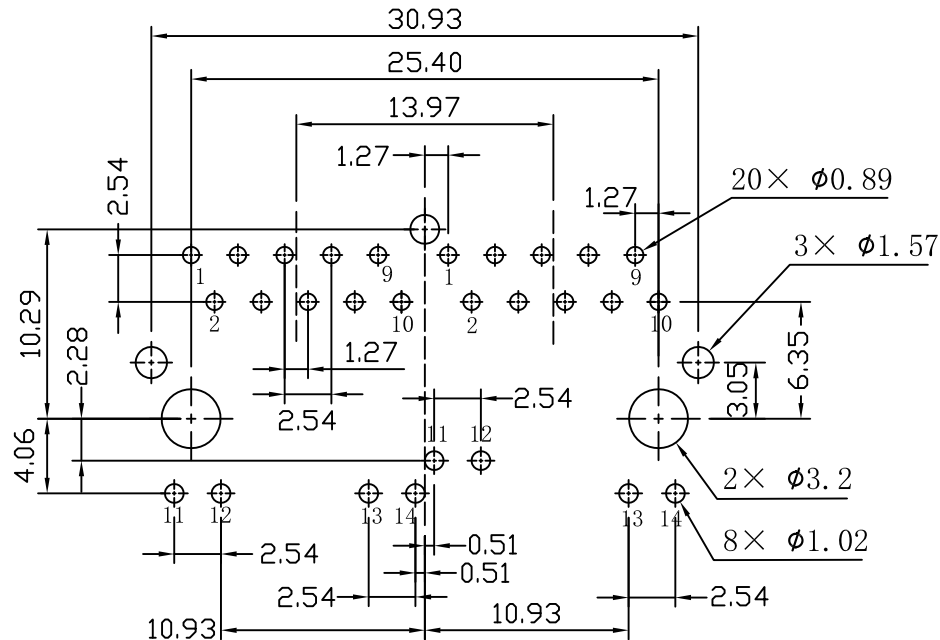

SUGGESTED PCB LAYOUT (TOP VIEW)

NOTES:

1. Designed to support application, such as SOHO (ADSL modems), LAN-on-Motherboard (LOM), hub and Switches.
2. Meets IEEE 802.3 specification
3. Connector Materials:
 Housing: Thermoplastic PBT+30%G.F UL94V-0
 Contact: Phosphor Bronze C5210R-EH Thickness=0.35mm
 Pins: Brass C2680R-H Thickness=0.35mm
 Shield: SUS 201-1/2H Thickness=0.2mm
 Contact plating: Gold 6 micro-inches min. In contact area.
4. Wave solder tip temperature: 265°C Max, 5 Sec Max.
5. UL Certification: File Number E484635.



| | | |
|-------------|------------|---|
| X:X ±0.30 | APPD: | LINK-PP INT'L TECHNOLOGY CO., LIMITED |
| X:XX ±0.25 | CHKD: | |
| X:XXX ±0.05 | DR: TOM | TITLE: 1*2 RJ45 Connector with 1000 BASE-T Integrated Magnetics |
| ANGLES ±1° | UNIT: mm | PART NO.: LPJG26813AENL |
| | SCALE: 2/1 | SHEET: 2/2 |
| | REV: A | DWG NO.: LP15042753 |