

Schematic:

| REV. | ECN NO. | DESCRIPTION | DATE | APPD |
|------|---------|-------------|------------|------|
| A | REL | | 2011/02/15 | |

PC BOARD CONNECTIONS

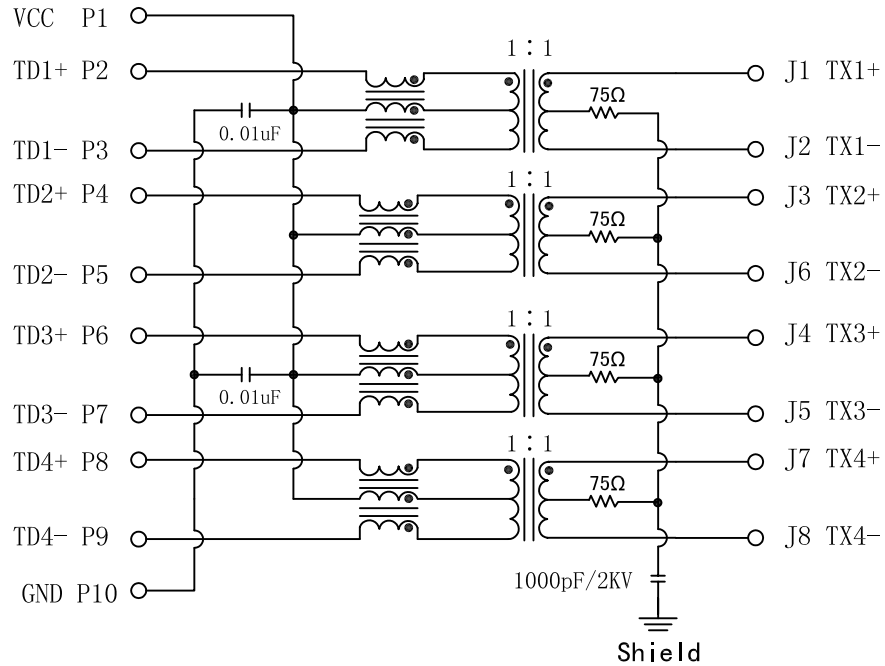

RJ45 CONNECTOR

Electrical Specifications @25°C

- Impedance: 100 ohms
- OCL: 350uH Min
@100KHz, 0.1V, 8mADC BIAS
- Turns Ratio: 1 : 1 ±3%
- Insertion Loss:
1-100MHz: -1.1dB Max
- Return Loss (dB Min):
1-40MHz: -18 60MHz: -14
80MHz: -12 100MHz: -10
- Crosstalk:
1-100MHz: -35dB Typ
- Common Mode Rejection (dB Typ):
0.1-30MHz: -38 30-60MHz: -35
60-100MHz: -30
- Isolation Voltage: 1500Vrms
- Operating Temperature: 0~70°C

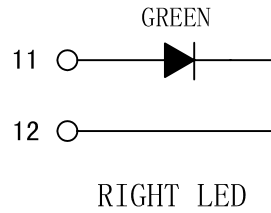
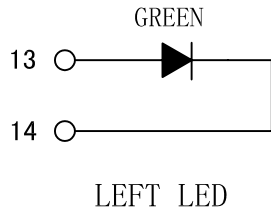

| | | | |
|--------|------------|------------|---|
| X:X | ±0.20 | APPD: | LINK-PP INT'L TECHNOLOGY CO., LIMITED |
| X:XX | ±0.10 | CHKD: | |
| X:XXX | ±0.05 | DR: TOM | Title: Vertical RJ45 Connector With 1000 Magnetic |
| ANGLES | ±1° | UNIT: mm | PART NO.: LPJD0773BFNL |
| | SCALE: 2/1 | SHEET: 1/2 | REV: A |
| | | | LP11021502 |

Mechanical :

| REV. | ECN NO. | DESCRIPTION | DATE | APPD |
|------|---------|-------------|------------|------|
| A | REL | | 2011/02/15 | |

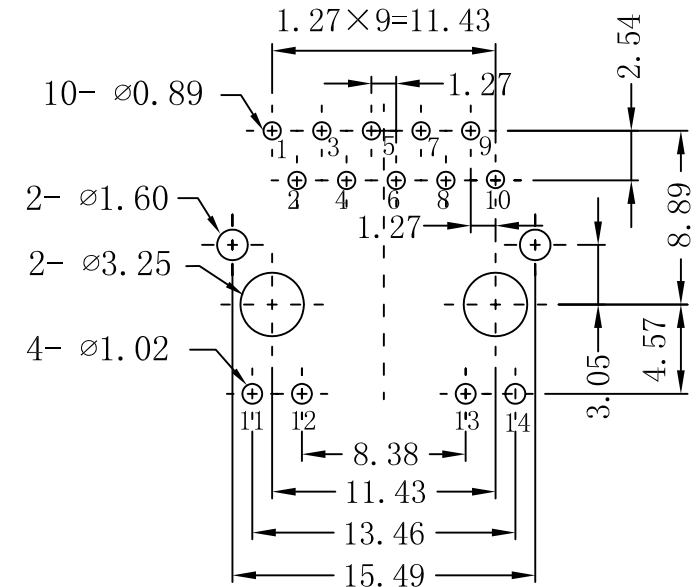
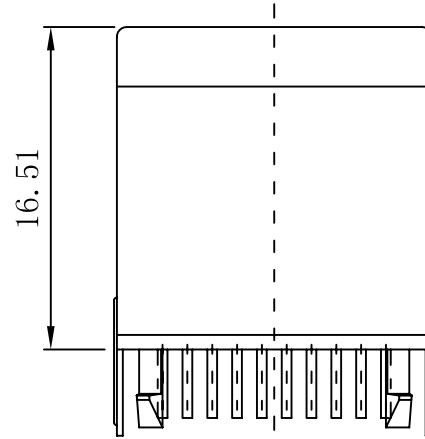
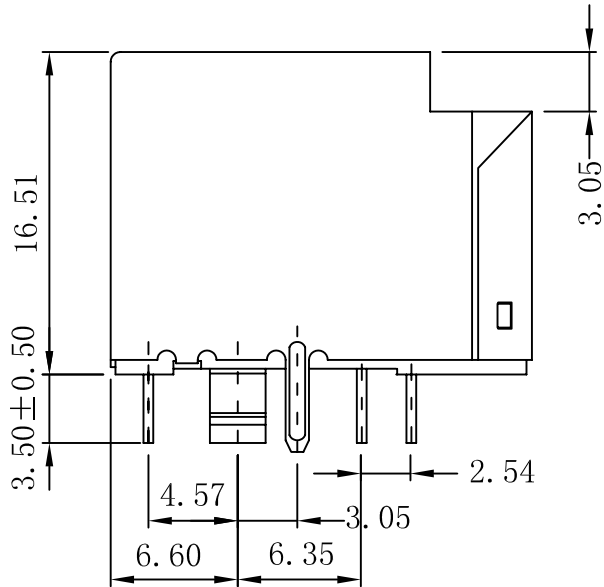

SUGGESTED PCB LAYOUT (TOP VIEW)

NOTES:

1. Designed to support application, such as SOHO (ADSL modems), LAN-on-Motherboard (LOM), hub and Switches.
2. Meets IEEE 802.3 specification
3. Connector Materials:
 Housing: Thermoplastic UL94V-0
 Contact/Shield: Copper alloy
 Shield plating: Nickel
 Contact plating: Gold 6 micro-inches min. In contact area.
4. Wave solder tip temperature: 260°C
 Wave solder tip temperature time: 5 Sec Max

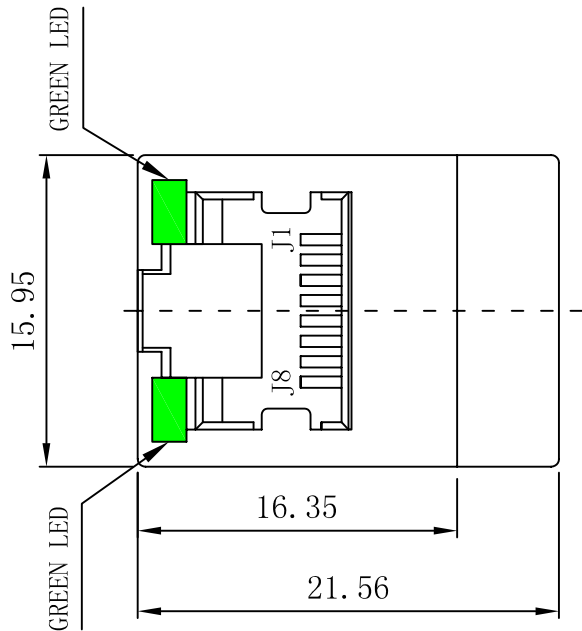

| | | | |
|--------|------------|------------|---|
| X:X | ±0.20 | APPD: | LINK-PP INT'L TECHNOLOGY CO., LIMITED |
| X:XX | ±0.10 | CHKD: | |
| X:XXX | ±0.05 | DR: TOM | Title: Vertical RJ45 Connector With 1000 Magnetic |
| ANGLES | ±1° | UNIT: mm | PART NO.: LPJD0773BFNL |
| | SCALE: 2/1 | SHEET: 2/2 | REV: A DWG NO.: LP11021502 |