

Schematic:

REV.	ECN NO.	DESCRIPTION	DATE	APPD
A	REL		2015-05-11	

PC BOARD CONNECTIONS

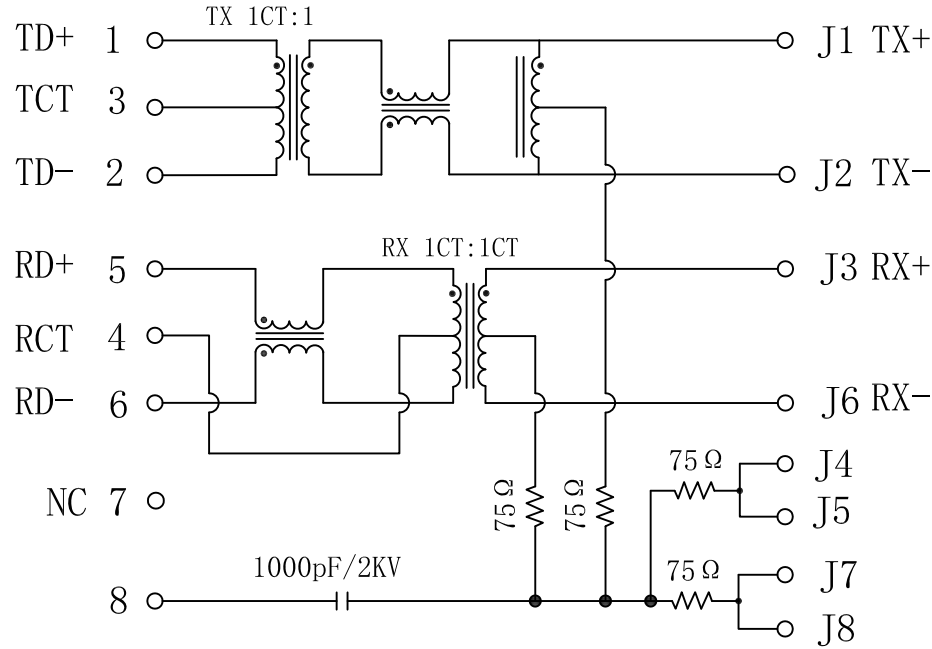

RJ45 CONNECTOR

ELECTRICAL SPECIFICATIONS @25°C

- Turn Ratio ($\pm 3\%$):
TX=1CT:1CT RX=1CT:1CT
- Inductance OCL:
350uH MIN @ 100KHz 0.1V 8mA DC Bias
- DCR: 1.2Ω MAX
- Insertion Loss:
-1.0dB MAX @ 1-100MHz
- Return Loss:
-20dB MIN @ 1-10MHz
-16dB MIN @ 30MHz
-12dB MIN @ 60-80MHz
- Cross talk:
-40dB MIN @ 1-30MHz
-35dB MIN @ 30-60MHz
-30dB MIN @ 60-100MHz
- Common Mode Rejection:
-30dB MIN @ 1-50MHz
-20dB MIN @ 50-100MHz
- Hipot Test: 1500Vrms
- Operating Temperature Range: 0°C TO 70°C

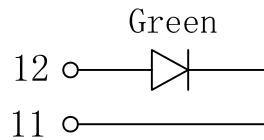

Left LED

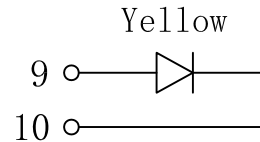

Right LED

Emitting Color	λ p(nm)	V _F @I _F =20mA	I _R @V _R =5V
Green	565	1.8~2.4V	10 μ A max
Yellow	585	1.8~2.4V	10 μ A max

X:X	± 0.25	APPD:	LINK-PP INT'L TECHNOLOGY CO., LIMITED	
X:XX	± 0.20	CHKD:	TITLE: Surface Mount RJ45 Connector with 10/100 Base-T Integrated Magnetics	
X:XXX	± 0.05	DR: TOM	PART NO.: LPJ3026BBNL	
ANGLES	$\pm 1^\circ$	UNIT: mm		
	SCALE: 2/1	SHEET: 1/2	REV: A	DWG NO.: LP15051263

Mechanical:

REV.	ECN NO.	DESCRIPTION	DATE	APPD
A	REL		2015-05-11	

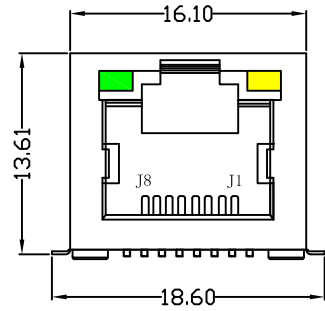

Front Side View

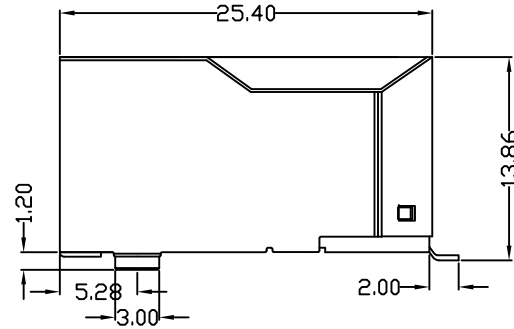

Left Side View

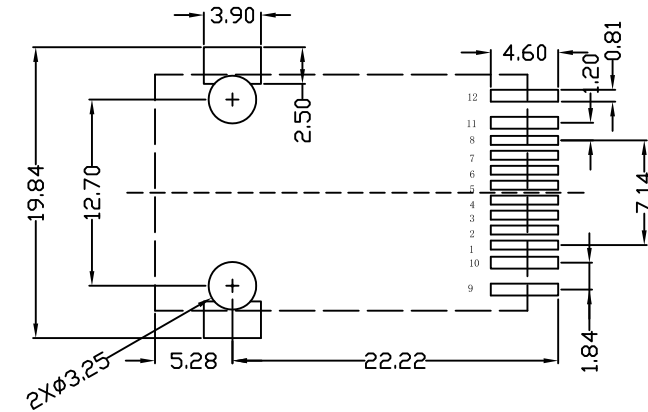

Suggested PCB Layout (Top View)

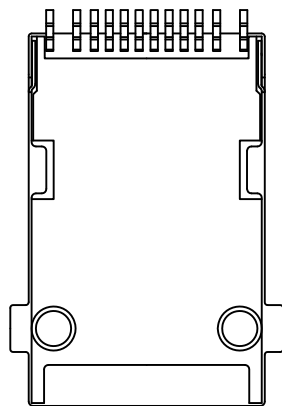
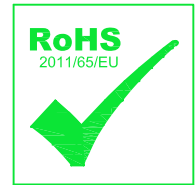

Bottom Side View

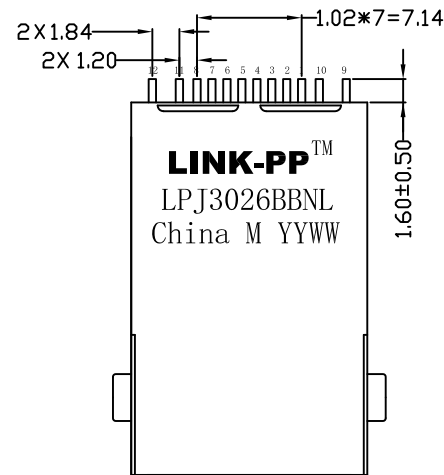

Top Side View

NOTES:

- Meets IEEE 802.3 specification
- Connector Materials:
 - Housing Material: Thermoplastic LCP+30%G.F UL94V-0
 - Contact Material: Phosphor Bronze C5210R-EH Thickness=0.35mm
 - Pins: Brass C2680R-H Thickness=0.35mm
 - Shield: SUS 201-1/2H Thickness=0.2mm
 - Contact plating: Gold 6 micro-inches min. In contact area.
- Wave solder tip temperature: 265°C Max, 5 Sec.
- UL Certification: File Number E484635.

X:X	±0.25	APPD:	LINK-PP INT'L TECHNOLOGY CO., LIMITED	
X:XX	±0.20	CHKD:	TITLE: Surface Mount RJ45 Connector with 10/100 Base-T Integrated Magnetics	
X:XXX	±0.05	DR: TOM	PART NO.: LPJ3026BBNL	
ANGLES	±1°	UNIT: mm	DWG NO.: LP15051263	
	SCALE: 2/1	SHEET: 2/2	REV: A	