

Schematic:

REV.	ECN NO.	DESCRIPTION	DATE	APPD
A	REL		2014-07-21	

PCB

CABLE

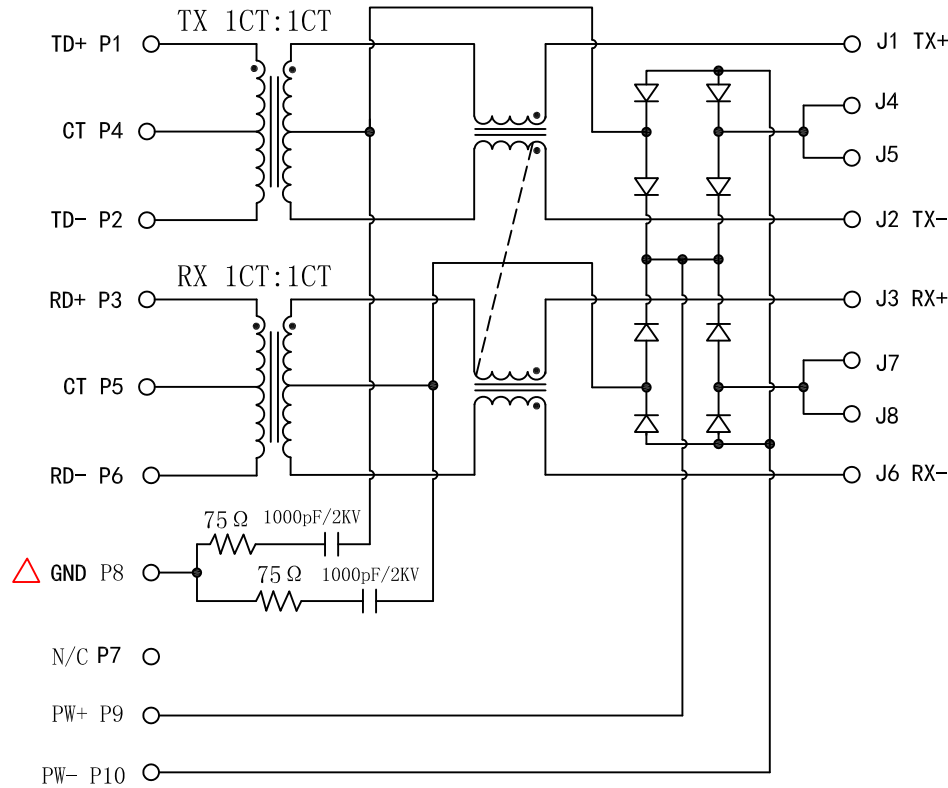

ELECTRICAL SPECIFICATIONS @25°C

- Turn Ratio(100KHz, 0.1V):
 PINS: (1-2) : (J1-J2)=1 : 1 ±3%
 PINS: (3-6) : (J3-J6)=1 : 1 ±3%
- OCL(@100KHz, 100mV, 8mA DC Bias):
 PINS: (1-3), (4-6)=350uH MIN
- Insertion Loss:
 -1.1dB MAX @0.1~100MHz
- Return Loss:
 -18dB MIN @0.5~30MHz
 -15.5dB MIN @40MHz
 -13.6dB MIN @50MHz
 -12dB MIN @60~80MHz
- Cross talk:
 -38dB TYP @1~100MHz
- Common Mode Rejection:
 -50dB TYP @0.1~30MHz
 -40dB TYP @30~60MHz
 -30dB TYP @60~100MHz
- Hipot Test: 1500Vrms
- Operating Temperature: 0°C TO 70°C.

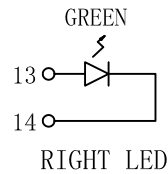
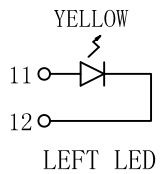

Emitting Color	λ p(nm)	VF@IF=20mA	IR @VR=5V
Green	565	1.8~2.6V	10 μ A max
Yellow	590	1.8~2.6V	10 μ A max

X:X ±0.30	APPD:	LINK-PP INT'L TECHNOLOGY CO., LIMITED
X:XX ±0.25	CHKD:	
X:XXX ±0.05	DR:	TITLE: RJ45 Connector with 10/100 Base-T Integrated Magnetics For PoE Application
ANGLES ±1°	UNIT: mm	PART NO.: LPJ0112GDNL
	SCALE: 2/1	SHEET: 2/2
	REV: A	DWG NO.: LP14072136

Mechanical:

REV.	ECN NO.	DESCRIPTION	DATE	APPD
A	REL		2014-07-21	

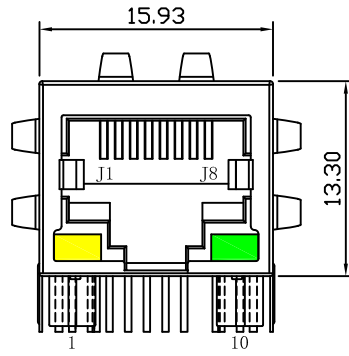

Front Side View

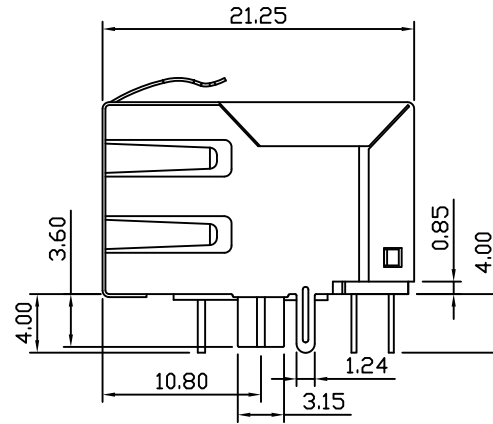

Left Side View

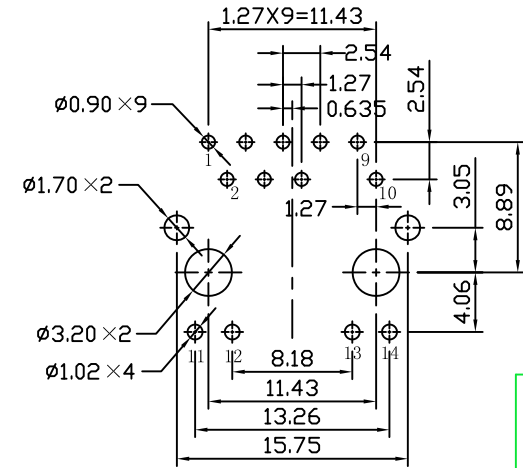

Suggested PCB Layout (Top View)

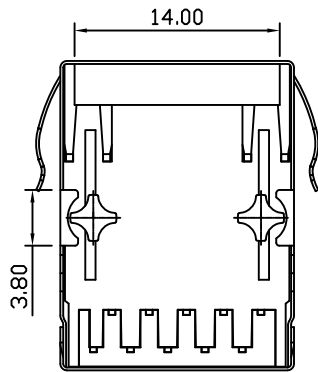

Bottom Side View

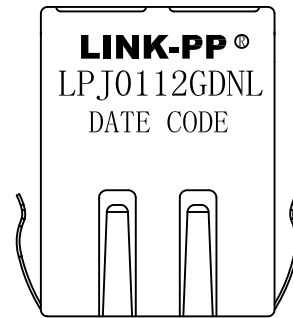

Top Side View

NOTES:

1. Designed to support application, such as SOHO (ADSL modems), LAN-on-Motherboard (LOM), hub and Switches.
2. Meets IEEE802.3af specification
3. Connector Materials:
 Housing: Thermoplastic PBT+30%G. F UL94V-0
 Contact: Phosphor Bronze C5210R-EH Thickness=0.35mm
 Pins: Brass C2680R-H Thickness=0.35mm
 Shield: SUS 201-1/2H Thickness=0.2mm
 Contact plating: Gold 6 micro-inches min. In contact area.
4. Wave solder tip temperature: 265°C Max, 5 Sec Max.
5. UL Certification: File Number E484635.

X:X	±0.30	APPD:	LINK-PP INT'L TECHNOLOGY CO., LIMITED	
X:XX	±0.25	CHKD:	TITLE: RJ45 Connector with 10/100 Base-T Integrated Magnetics For PoE Application	
X:XXX	±0.05	DR: TOM	PART NO.: LPJ0112GDNL	
ANGLES	±1°	UNIT: mm	DWG NO.: LP14072136	
	SCALE: 2/1	SHEET: 2/2	REV: A	