

Schematic:

REV.	ECN NO.	DESCRIPTION	DATE	APPD
A	REL		2010-03-20	

PC BOARD CONNECTIONS

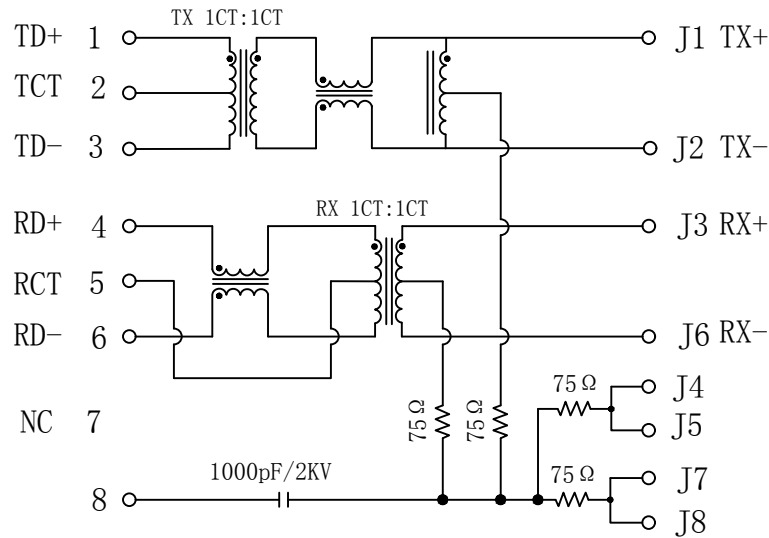

RJ45 CONNECTOR

ELECTRICAL SPECIFICATIONS @25°C

- Turn Ratio ($\pm 2\%$):
TX=1CT:1CT RX=1CT:1CT
- Inductance OCL: 350uH MIN
@100KHz, 0.1V, 8mA DC Bias
- Insertion Loss:
-1.0dB MAX @1~65MHz
- Return Loss:
-20dB MIN @1~10MHz
-16dB MIN @10~30MHz
-12dB MIN @30~60MHz
-10dB MIN @60~100MHz
- Cross talk:
-40dB MIN @1~30MHz
-35dB MIN @30~60MHz
-30dB MIN @60~100MHz
- Common Mode Rejection:
-30dB MIN @1~50MHz
-20dB MIN @50~150MHz
- Hipot Test: 1500Vrms MIN
- Operating Temperature Range: 0°C~70°C.



X:X	± 0.30	APPD: TOM	LINK-PP INT'L TECHNOLOGY CO., LIMITED	
X:XX	± 0.25	CHKD: JAMES		
X:XXX	± 0.05	DR: LEO	TITLE: RJ45 Connector with 10/100 Base-T Integrated Magnetics	
ANGLES	$\pm 1^\circ$	UNIT: mm	PART NO.: LPJ00417CNL	
	SCALE: 2/1	SHEET: 1/2	REV: A	DWG NO.: LP22062405

Mechanical:

REV.	ECN NO.	DESCRIPTION	DATE	APPD
A	REL		2010-03-20	

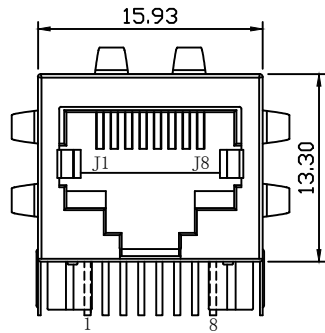

Front Side View

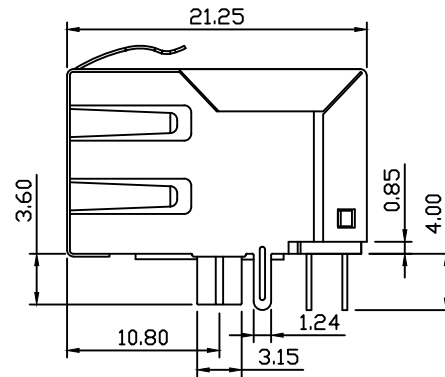

Left Side View

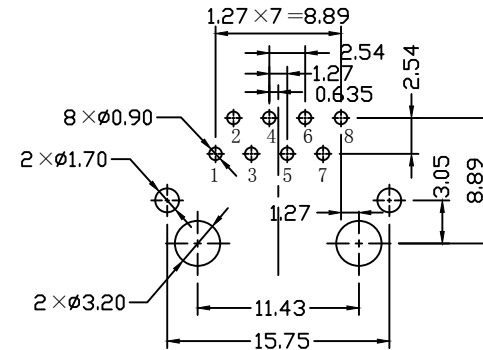

Suggested PCB Layout (Top View)

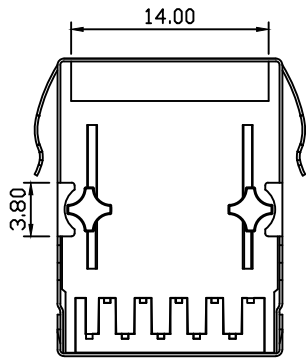

Bottom Side View

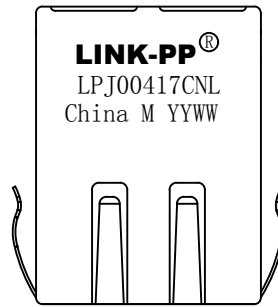

Top Side View

NOTES:

1. Designed to support application, such as SOHO (ADSL modems), LAN-on-Motherboard (LOM), hub and Switches.
2. Meets IEEE 802.3 specification
3. Connector Materials:
 Housing: Thermoplastic PBT+30%G.F UL94V-0
 Contact: Phosphor Bronze C5210R-EH Thickness=0.35mm
 Pins: Brass C2680R-H Thickness=0.35mm
 Shield: SUS 304-1/2H Thickness=0.2mm
 Contact plating: Gold 6 micro-inches min. In contact area.
4. Wave solder tip temperature: 260°C, 5 Sec.
5. UL Certification: File Number E484635.



X:X	±0.30	APPD:	TOM	LINK-PP INT'L TECHNOLOGY CO., LIMITED
X:XX	±0.25	CHKD:	JAMES	
X:XXX	±0.05	DR:	LEO	TITLE: RJ45 Connector with 10/100 Base-T Integrated Magnetics
ANGLES	±1°	UNIT:	mm	PART NO.: LPJ00417CNL
	SCALE:	2/1	SHEET:	2/2
	REV:	A	DWG NO.:	LP22062405