

REV	DESCRIPTION OF CHANGE	REVIEWED BY	ISSUE DATE
B	FIRST ISSUE	LEO	2024-02-11

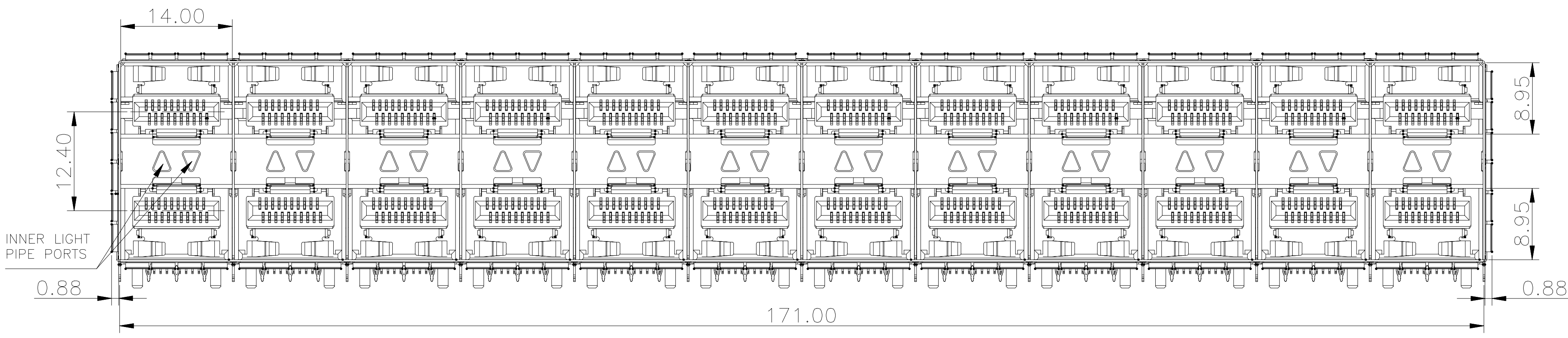

NOTES:
MATERIAL:
CAGE: COPPER ALLOY NI-PLATED, THICKNESS 0.25 MM
CONNECTOR:
PLASTIC HOUSING: HIGH TEMPERATURE LCP, UL94 V-0.
SPRING: STAINLESS STEEL, THICKNESS 0.20mm
CONTACTS: PHOSPHOR BRONZE, THICKNESS 0.20mm
PLATING: 15 μ " MIN. GOLD ON MATING AREA,
150 μ " MIN. MATE TIN ON SOLDER TAILS.
PACKAGING: TRAY PACKAGING.
TEMPERATURE RANGE: -40°C TO +85°C

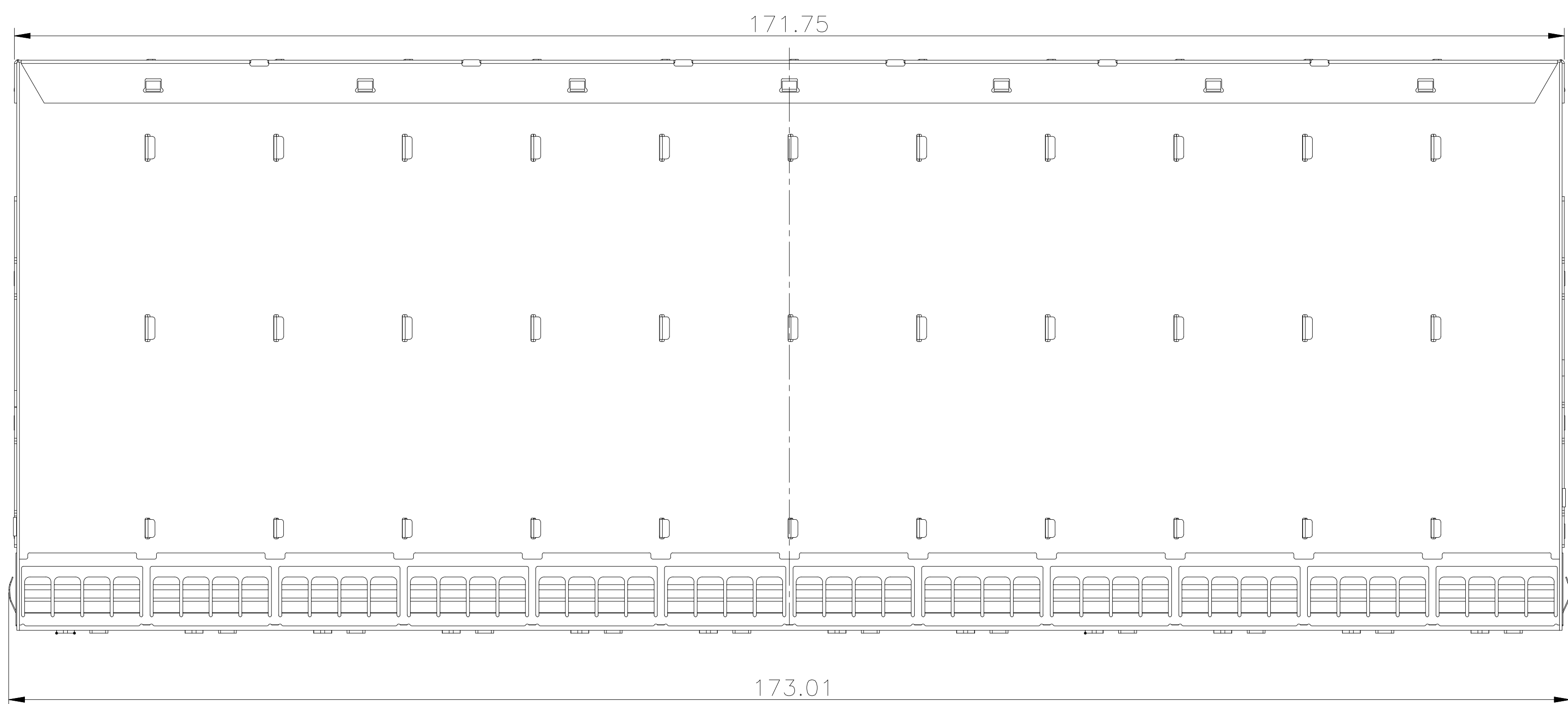
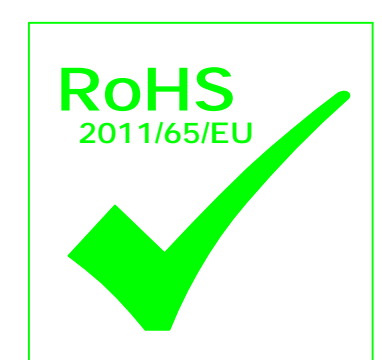
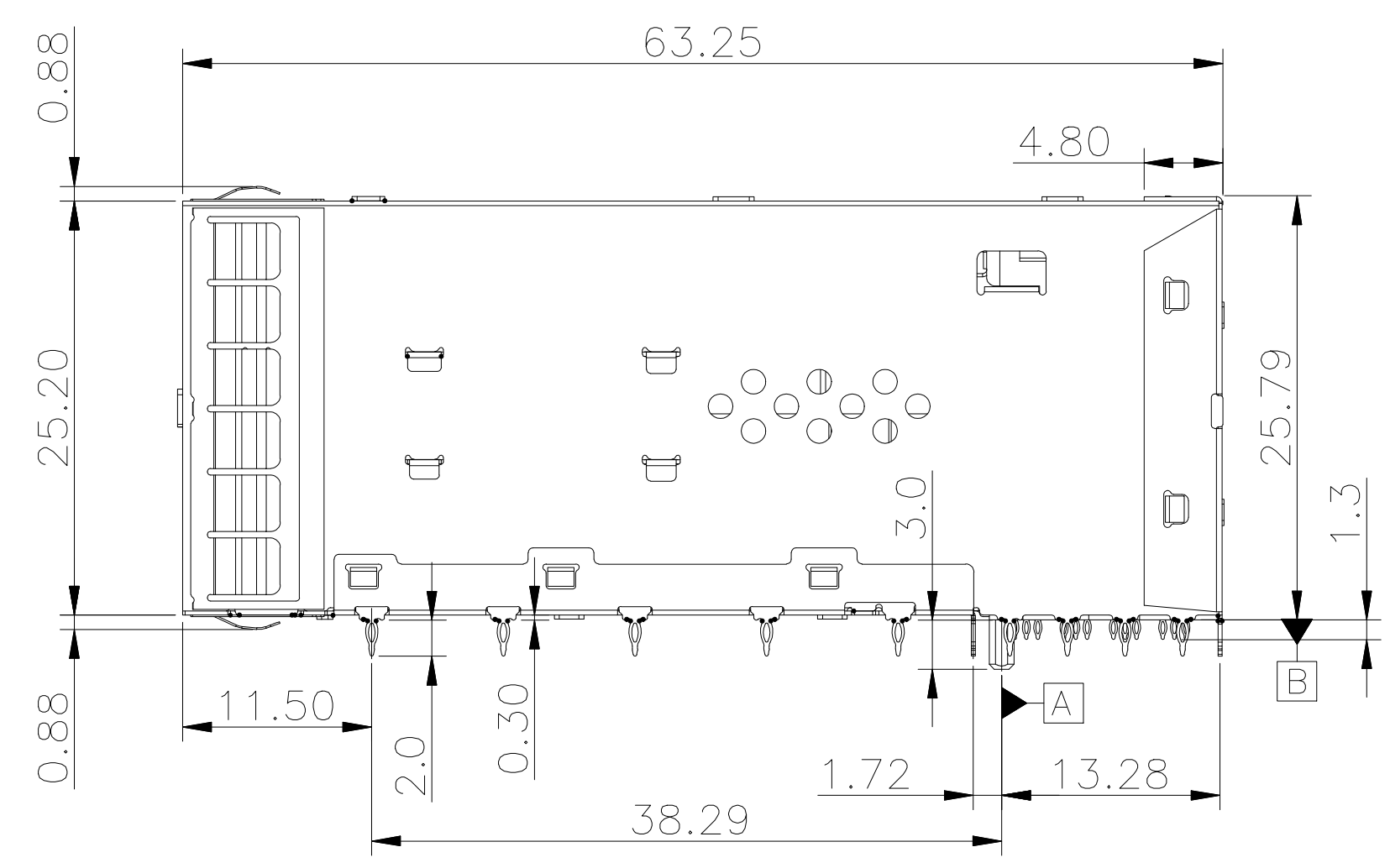

TITLE SFP28 2X12 CAGE & CONNECTOR WITH EMI SPRING FINGER LIGHT PIPE			LINK-PP INT'L TECHNOLOGY CO., LIMITED		
PART NO. LP212CC01201			GENNERAL TOLERANCE		UNIT:MM
APPROVE	CHECK	DRAW	◦ X±0.20	◦ X±1°	SIZE:A4
LEO	JAMES	JAMES	◦ XX±0.15	◦ XX±5°	SCALE:1:1
			◦ XXX±0.10		SHEET:1/4
					REV:B

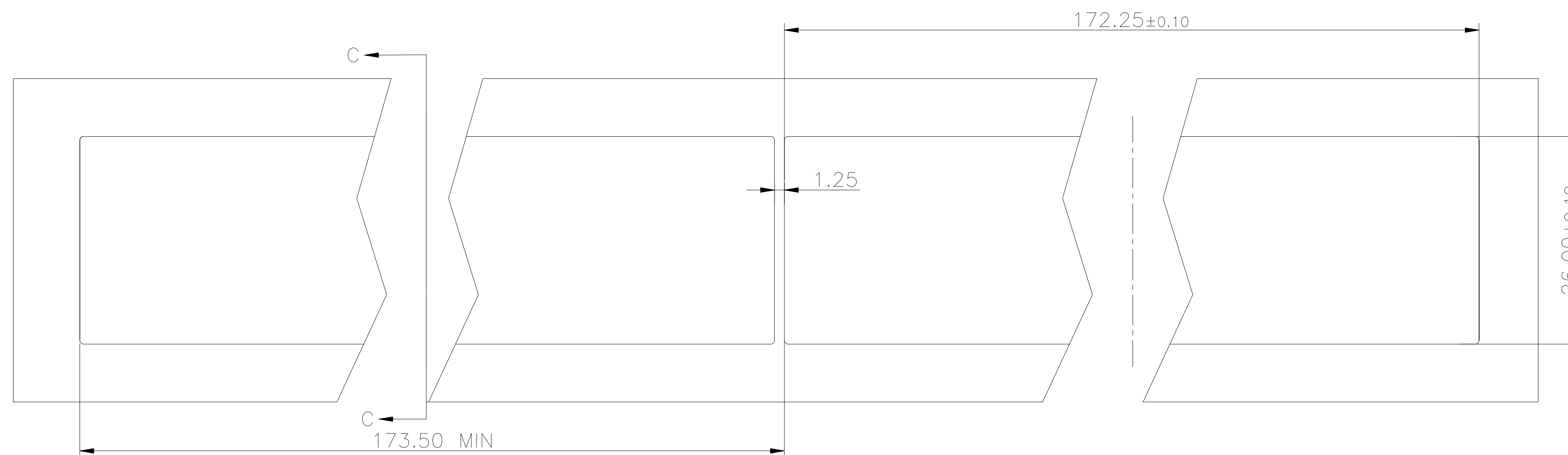

BEZEL CUT-OUT CENTER SPACING DETAIL
BEZEL THICKNESS:0.8-2.6

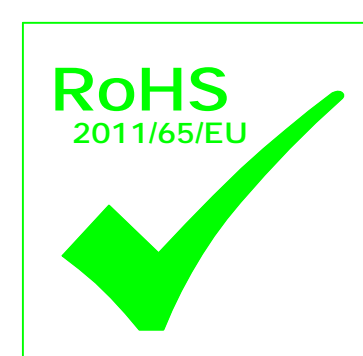
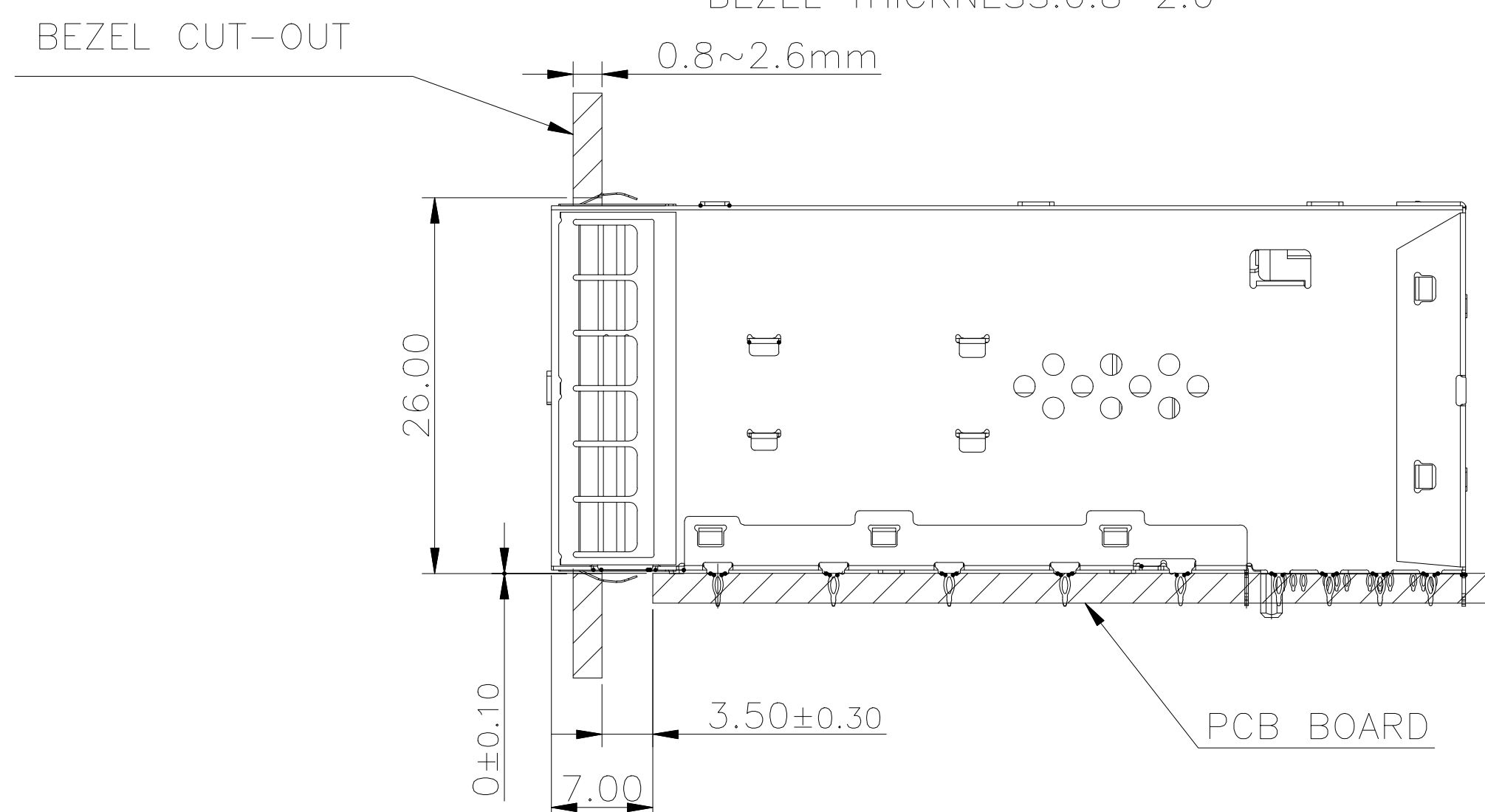

TITLE SFP28 2X12 CAGE & CONNECTOR WITH EMI SPRING FINGER LIGHT PIPE			LINK-PP INT'L TECHNOLOGY CO., LIMITED				
PART NO. LP212CC01201			GENNERAL TOLERANCE			UNIT:MM	SIZE:A4
APPROVE	CHECK	DRAW	° X±0.20	° X±1°	SCALE:1:1	SHEET:2/4	REV:B
LEO	JAMES	JAMES	° XX±0.15	° XX±5°			
			° XXX±0.10				

PACKAGE INFORMATION AND LABEL

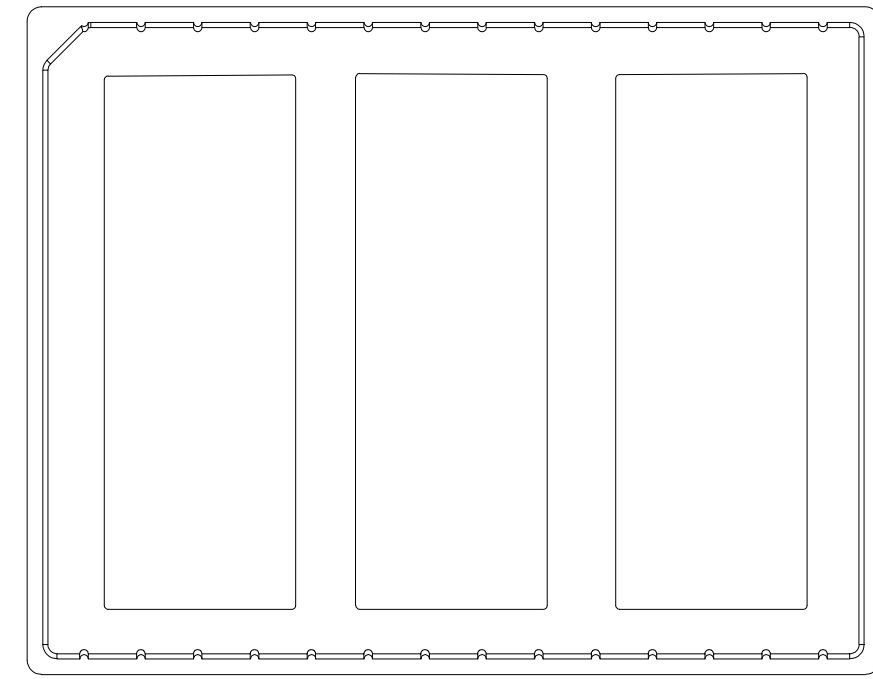

1. 3PCS PRODUCTS IN TRAYS

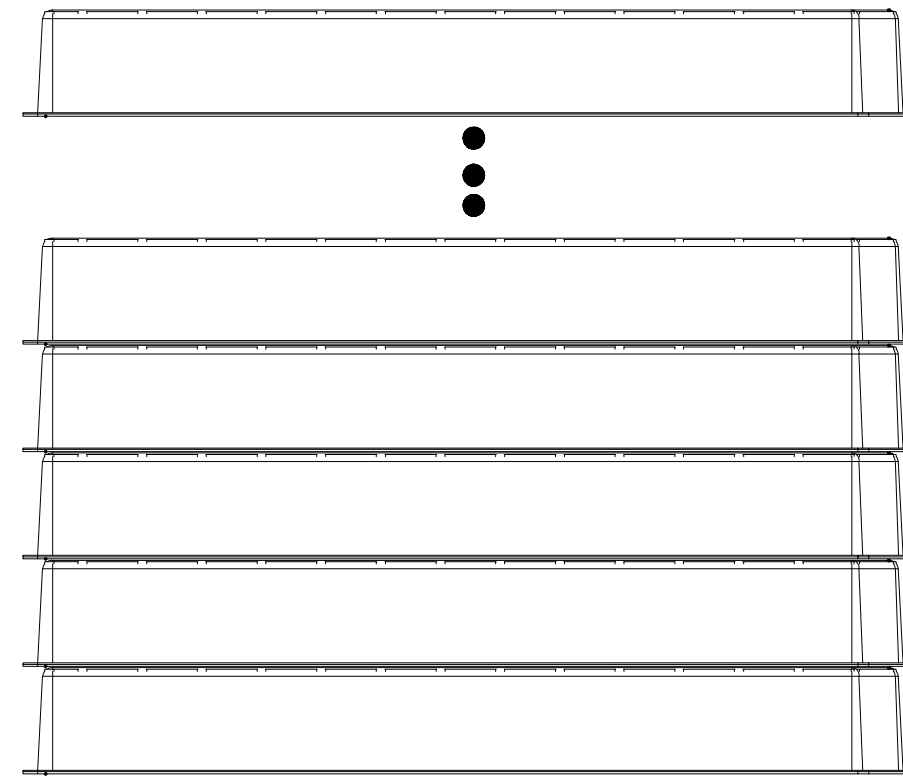
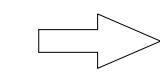

2. 4PCS TRAYS OVERLAY:
(THE NEXT TRAY NEED ROTATE 180 DEGREE AND PUT IT ON PREVIOUS TRAY.)

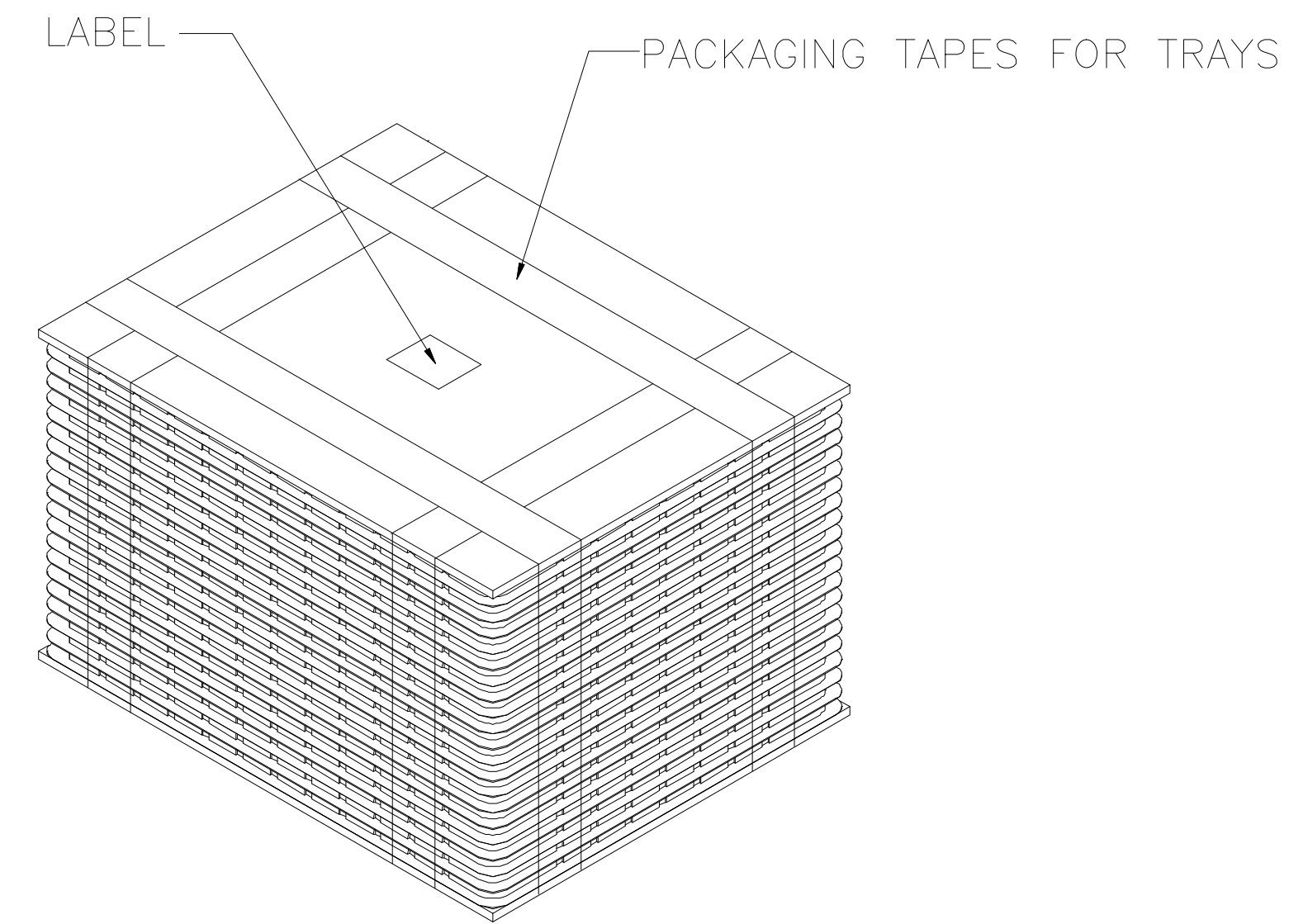
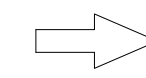

3. LABEL & PACKAGING TAPES FOR TRAYS:

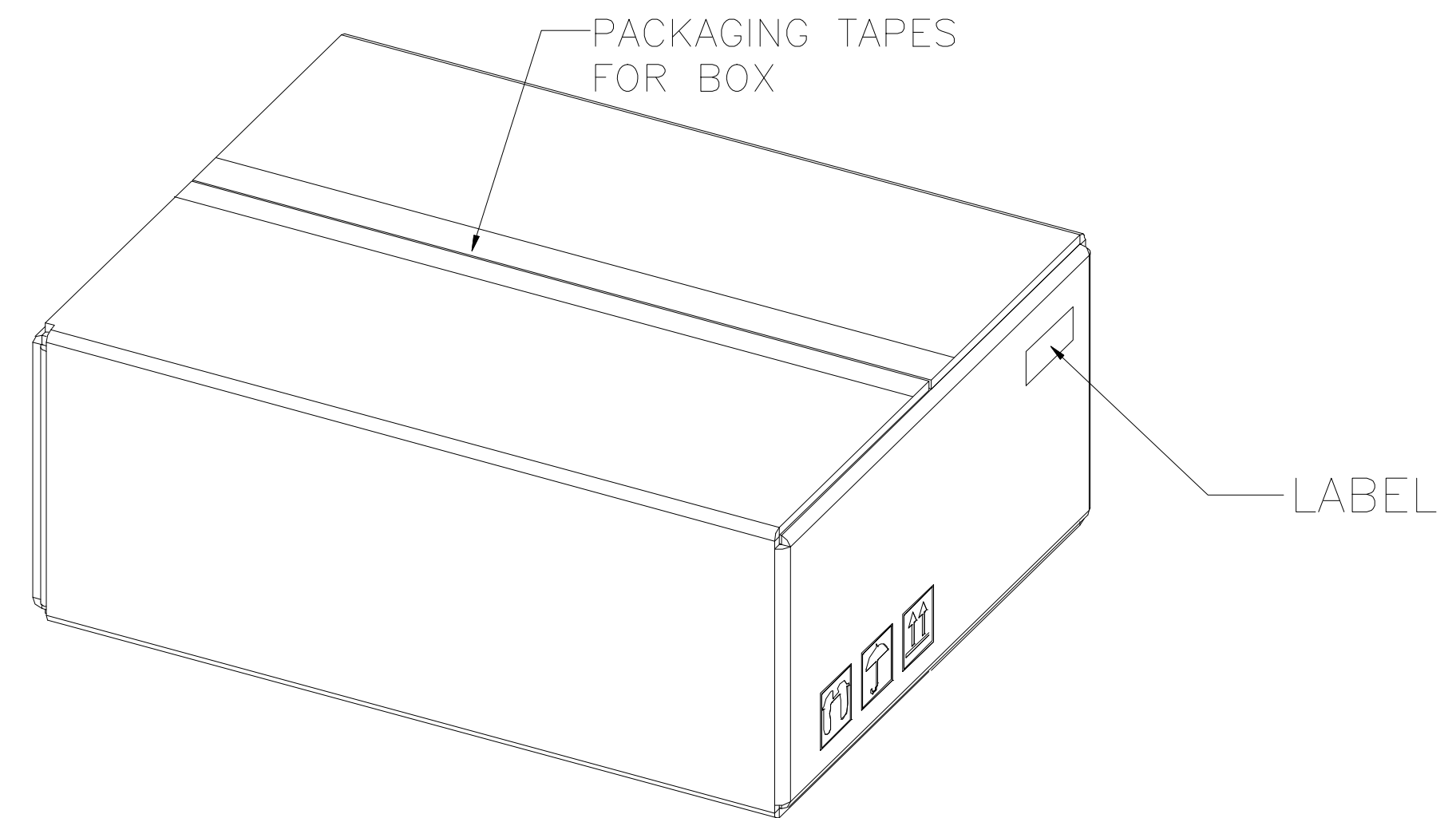
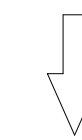

4. LABEL & PACKAGING TAPES FOR BOX

PACKAGING LISTS	
ITEM	Q'TY
PRODUCT	12 PCS
TRAY	4 PCS
BOX(L340*W265*H200MM)	1 PCS
LABLE	2 PCS
PACKAGING TAPES	8 M (ABOUT)

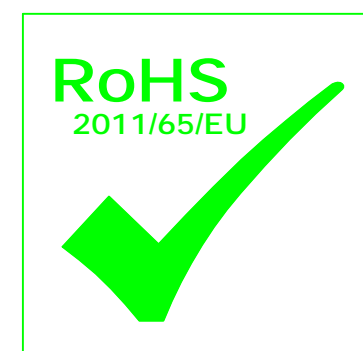

TITLE SFP28 2X12 CAGE & CONNECTOR WITH EMI SPRING FINGER LIGHT PIPE			LINK-PP INT'L TECHNOLOGY CO., LIMITED				
PART NO. LP212CC01201			GENNERAL TOLERANCE			UNIT:MM	SIZE:A4
APPROVE	CHECK	DRAW	◦ X±0.20	◦ X±1°	SCALE:1:1	SHEET:4/4	REV:B
LEO	JAMES	JAMES	◦ XX±0.15	◦ XX±5°			
			◦ XXX±0.10				